

www.meridianintl.com



2021 STORAGE SOLUTIONS CATALOGUE

MERIDIAN

美瑞实业



Meridian LJ: A 40,000m² facility located in Shanghai for all packaging and distribution coordination activities.

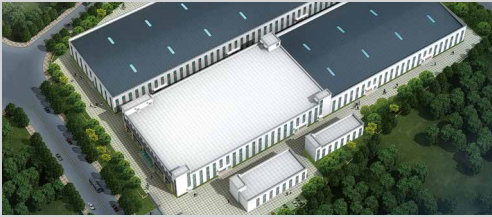

Meridian LT: A 40,000m² facility located in Pinghu, Zhejiang province for the production of all injection molded plastic products.



Meridian LM: A 50,000m² facility located in Jinhua, Zhejiang province for the production of all steel storage items including storage racks and garage storage systems.



Toolux Sanding: A 67,000m² facility located in Shengzhou, Zhejiang province for the production of hand tools.



Mei Zhi : A 33,000 m² facility located in Cixi, Zhejiang province for the production of watering tools.



Since 1992, Meridian International, an ISO9001 accredited company, has successfully established itself as one of the leading organizations serving the tool and hardware market, becoming the headquarters for an effective group of manufacturers with the proven capabilities of serving global customers. Such ability can be attributed to the synchronized approach to manufacturing taken by Meridian, following a collaborative process of internal research, product development and graphic design together with proven sourcing, manufacturing, and distribution capabilities.

Currently, we utilize a team containing more than 30 engineers and industrial designers who are involved in the coordination and execution of conceptual design, mechanical design, and the overall project management activities. In addition to our ongoing cooperation with some of the world's leading design houses, we currently have international branches located in Australia, Luxembourg, United Kingdom, Latin America, United States of America to guarantee our products strength across the competitive global markets. This comprehensive process ensures both the originality and superior quality of our products.

Meridian International also utilizes strong sourcing capabilities, currently working in co-operation with 700+ factories across China and in several other Asian countries. Our experienced product managers and sourcing specialists are constantly working with customers on the development and management of their product ranges.



Meridian International Co., Ltd.

www.meridianintl.com

Content.

Product range.



Plastic tool box

02 - 28



Organizer

29 - 55



Plastic storage bin

56 - 65



Home use storage

66 - 75



Other plastic storage

76 - 84



Metal portable tool box

85 - 89



Tool chest & cabinet

90 - 115



Accessories

116 - 117

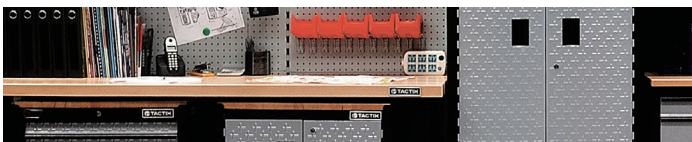

Garage storage system

118 - 134



Storage hook system

135 - 138



Storage rack series

139 - 143



PRO & Soft storage

144 - 153



320130 33 cm (13 in.) Plastic Tool Box

- 33 W x 16 D x 13 H cm (13 x 6-1/4 x 5-1/8 in.)
- Sturdy carrying handle
- High impact plastic
- Lift out carry tray
- Ships nested in the master carton



Case Pack	Case Weight	Case Size	20' FCL	40' FCL	40' HQ
12	6.8 kg (15 lbs.)	34.5 x 33.5 x 49 cm (13-1/2 x 13 x 9-1/4 in.)	4,896	10,080	12,600



320132 43.5 cm (17 in.) Plastic Tool Box

- 43.5 W x 21 D x 19 H cm (17 x 8-1/4 x 7-1/2 in.)
- Sturdy carrying handle
- High impact plastic
- Lift out carry tray
- Built-in organization compartments
- Ships nested in the master carton



Case Pack	Case Weight	Case Size	20' FCL	40' FCL
15	18 kg (39.7 lbs.)	45.5 x 44.5 x 72.5 cm (18 x 17-1/2 x 28-1/2 in.)	2,925	5,850



320134 51 cm (20 in.) Plastic Tool Box

- 51 W x 27 D x 23.5 H cm (20 x 10-1/2 x 9-1/4 in.)
- Sturdy carrying handle
- High impact plastic
- Lift out carry tray
- Built-in organization compartments
- Ships nested in the master carton



Case Pack	Case Weight	Case Size	20' FCL	40' FCL	40' HQ
12	21.8 kg (48 lbs.)	55.5 x 53 x 65 cm (21-7/8 x 20-7/8 x 25-1/2 in.)	1,584	3,168	4,224



320138 3 PC Tool Box Set

- 51 W x 27 D x 23.5 H cm (20 x 10-1/2 x 9-1/4 in.)
- 43.5 W x 21 D x 19 H cm (17 x 8-1/4 x 7-1/2 in.)
- 33 W x 16 D x 13 H cm (13 x 6-1/4 x 5-1/8 in.)
- Sturdy carrying handle
- High impact plastic
- Lift out carry tray



Case Pack	Case Weight	Case Size	20' FCL	40' FCL	40' HQ
4	14.2 kg (31 lbs.)	56 x 53 x 51 cm (22 x 20-7/8 x 20 in.)	704	1,408	1,760

320103 33 cm (13 in.) Plastic Tool Box

- 33 W x 15.4 D x 13.2 H cm (13 x 6 x 5-1/8 in.)
- Built-in organization compartments
- Lift-out carry tray
- Cam-action ABS latches
- Weather-proof function



Case Pack	Case Weight	Case Size	20' FCL	40' FCL
15	9.1 kg (20 lbs.)	35 x 34 x 58 cm (13-3/4 x 13-3/8 x 22-7/8 in.)	6,120	12,600



320101 40.8 cm (16 in.) Plastic Tool Box

- 40.8 W x 20.8 D x 19.6 H cm (16 x 8-1/8 x 7-5/8 in.)
- Built-in organization compartments
- Lift-out carry tray
- Cam-action ABS latches
- Weather-proof function



Case Pack	Case Weight	Case Size	20' FCL	40' FCL
15	15.8 kg (34.8 lbs.)	44 x 43 x 69 cm (17-3/8 x 17 x 27-1/8 in.)	2,925	6,075



320100A 50 cm (19-1/2 in.) Plastic Tool Box

- 50 W x 26.3 D x 24 H cm (19-1/2 x 10-3/8 x 9-1/2 in.)
- Built-in organization compartments
- Lift-out carry tray
- Cam-action ABS latches
- Weather-proof function



Case Pack	Case Weight	Case Size	20' FCL	40' FCL	40' HQ
12	20.7 kg (45.6 lbs.)	55 x 52 x 64.5 cm 21-5/8 x 20-1/2 x 25-3/8 in.	1,584	3,312	4,416



320107 3 PC Plastic Tool Box Set

- 50 W x 26.3 D x 24 H cm (19-5/8 x 10-1/4 x 9-3/8 in.)
- 40.8 W x 20.8 D x 19.6 H cm (16 x 8-1/8 x 7-5/8 in.)
- 30 W x 15.4 D x 13.2 H cm (13 x 6 x 5-1/8 in.)
- Built-in organization compartments
- Lift-out carry tray
- Cam-action ABS latches
- Weather-proof function



Case Pack	Case Weight	Case Size	20' FCL	40' FCL	40' HQ
4	12.7 kg (28 lbs.)	54.5 x 52 x 51 cm (21-1/2 x 20-1/2 x 20 in.)	704	1,472	1,840



Tools & accessories not included



Tools & accessories not included



320341 40.8 cm (16 in.) Plastic Tool Box

- 40.8 W x 22.1 D x 18.7 H cm (16 x 8-3/4 x 7-3/8 in.)
- Heavy duty steel latches
- Lift-out carry tray



Case Pack	Case Weight	Case Size	20' FCL	40' FCL
20	22.3 kg (49.2 lbs.)	48 x 44 x 90 cm (18-7/8 x 17-1/2 x 35-1/2 in.)	2,520	5,240



320342 50.8 cm (20 in.) Plastic Tool Box

- 50.8 W x 26 D x 23.2 H cm (20 x 10-1/4 x 9 in.)
- Heavy duty steel latches
- Lift-out carry tray



Case Pack	Case Weight	Case Size	20' FCL	40' FCL
12	20.4 kg (45 lbs.)	55 x 54 x 78 cm (21-5/8 x 21-1/4 x 30-3/4 in.)	1,440	3,168



320343 58.5 cm (23 in.) Plastic Tool Box

- 58.5 W x 30 D x 26 H cm (23 x 11-3/4 x 10-1/4 in.)
- Heavy duty steel latches
- Lift-out carry tray



Case Pack	Case Weight	Case Size	20' FCL	40' FCL	40' HQ
12	28.6 kg (63 lbs.)	64 x 61 x 84 cm (25-1/4 x 24 x 33 in.)	648	1,368	2,052



320344 61 cm (24 in.) Plastic Tool Box

- 61 W x 27.7 D x 26.2 H cm (24 x 11 x 10-1/4 in.)
- Aluminum comfort-grip top handle
- 1 x Black PP tray inside
- 2 x Heavy-duty steel latches



Case Pack	Case Weight	Case Size	20' FCL	40' FCL	40' HQ
8	19.8 kg (43.7 lbs.)	62 x 57 x 60 cm (24-1/2 x 22-1/2 x 23-5/8 in.)	864	1,824	2,432



320345 40.6 cm (16 in.) Plastic Tool Box

- 40.6 W x 23.8 D x 22 H cm (16 x 9-3/8 x 8-5/8 in.)
- Heavy-duty steel latch
- Lift-out carry tray



Case Pack	Case Weight	Case Size	20' FCL	40' FCL	40' HQ
18	23 kg (50.7 lbs.)	84 x 51 x 65 cm (33 x 20 x 25-5/8 in.)	1,512	3,240	4,320

PLASTIC TOOL BOX

320111 40 cm (16 in.) Plastic Tool Box - Black

- 40 W x 22.5 D x 20.7 H cm (16 x 8-7/8 x 8-1/8 in.)
- Built-in organization compartments
- Lift-out carry tray



Case Pack	Case Weight	Case Size	20' FCL	40' FCL	40' HQ
4	5.5 kg (12.1 lbs.)	43 x 47 x 44 cm (17 x 18-1/2 x 17-1/2 in.)	1,280	2,660	3,192



320112 50.7 cm (20 in.) Plastic Tool Box

- 50.7 W x 25.4 D x 26.2 H cm (20 x 10 x 10-1/4 in.)
- Built-in organization compartments
- Lift-out carry tray



Case Pack	Case Weight	Case Size	20' FCL	40' FCL	40' HQ
4	8 kg (17.6 lbs.)	54 x 53 x 54 cm (22 x 21 x 22 in.)	704	1,408	1,760



320114 57.2 cm (22-1/2 in.) Plastic Tool Box

- 57.2 W x 30 D x 29.7 H cm (22-1/2 x 11-3/4 x 11-5/8 in.)
- Built-in organization compartments
- Lift-out carry tray



Case Pack	Case Weight	Case Size	20' FCL	40' FCL	40' HQ
2	6 kg (13 lbs.)	60 x 31 x 64 cm (23-1/2 x 12-1/4 x 25-1/4 in.)	450	960	1,120



320118 4 PC Plastic Tool Box Set

- 57.2 W x 30 D x 29.7 H cm (22-1/2 x 11-3/4 x 11-5/8 in.)
- 50.7 W x 25.4 D x 26.2 H cm (20 x 10 x 10-1/4 in.)
- 40 W x 22.5 D x 20.7 H cm (16 x 8-7/8 x 8-1/8 in.)
- 30.5 W x 15 D x 10 H cm (12 x 5-7/8 x 4 in.)
- Built-in organization compartments
- Lift-out carry tray (for 41 cm/16 in. tool box)



Case Pack	Case Weight	Case Size	20' FCL	40' FCL	40' HQ
2	11.6 kg (25.6 lbs.)	61 x 31 x 63 cm (24 x 12-1/4 x 24-3/4 in.)	450	960	1,120



320110 40 cm (16 in.) Plastic Tool Box - Colored

- 40 W x 22.5 D x 20.7 H cm (16 x 8-7/8 x 8-1/8 in.)
- Built-in organization compartments
- Lift-out carry tray
- Three compartment color options:



Case Pack	Case Weight	Case Size	20' FCL	40' FCL	40' HQ
4	5.5 kg (12.1 lbs.)	47.5 x 42.5 x 45 cm (18-5/8 x 16-3/4 x 17-3/4 in.)	1,280	2,660	3,192





321107 40.5 cm (16 in.) Tool Box

- 40.5 W x 21 D x 20 H cm (16 x 8-1/4 x 7-7/8 in.)
- 0.026 Cubic meters (1,590 cubic inches) capacity
- Comfort-grip handle for easy portability
- Durable metal latches



Case Pack	Case Weight	Case Size	20' FCL	40' FCL	40' HQ
1	1.9 kg (4.2 lbs.)	43 x 26 x 25 cm (17 x 10-1/4 x 9-7/8 in.)	1,053	2,160	2,400



321105 51 cm (20 in.) Plastic Tool Box

- 51 W x 23.5 D x 23 H cm (20 x 9-1/4 x 9 in.)
- Steel drawbolt
- Comfort-grip top handle
- Impact-resistant construction
- Liftout tote tray
- Padlock feature



Case Pack	Case Weight	Case Size	20' FCL	40' FCL	40' HQ
1	2.9 kg (6.4 lbs.)	53 x 28 x 27 cm (20-7/8 x 11 x 10-5/8 in.)	704	1,440	1,620



321106 58 cm (23 in.) Plastic Tool Box

- 58 W x 26.5 D x 25 H cm (23 x 10-1/2 x 9-3/4 in.)
- Steel drawbolt
- Comfort-grip top handle
- Impact-resistant construction
- Liftout tote tray
- Padlock feature



Case Pack	Case Weight	Case Size	20' FCL	40' FCL	40' HQ
1	4 kg (9 lbs.)	61 x 31 x 30 cm (24 x 12-1/4 x 12 in.)	462	952	1,088



PLASTIC TOOL BOX

320300 56 cm (22 in.) Cantilever Tool Box

- 56 W x 30.5 D x 16.5 H cm (22 x 12 x 6-1/2 in.)
- Professional grade construction
- Full length aluminum handle
- Cantilever function allows for full access to bottom box
- Steel latches for durability
- 15 Individual removable compartments

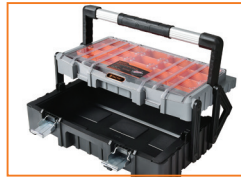

Case Pack	Case Weight	Case Size	20' FCL	40' FCL	40' HQ
2	7.3 kg (16 lbs.)	59 x 33 x 37 cm (23-1/4 x 13 x 14-1/2 in.)	792	1,680	1,960

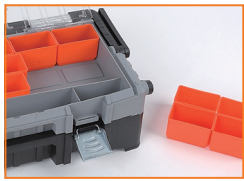

320304 56 cm (22 in.) Tool Box with Organizer

- 56 W x 28 D x 25 H cm (22 x 11 x 9-5/8 in.)
- Removable top organizer and tote tray
- Full length aluminum handle
- Steel latches



Case Pack	Case Weight	Case Size	20' FCL	40' FCL	40' HQ
1	4 kg (8.8 lbs.)	58 x 30 x 28 cm (22-7/8 x 11-7/8 x 11 in.)	608	1,280	1,440



TPR rubber grip feet for anti-shock



320318 51 cm (20 in.) Tool Box - 2 Hook-On Tubs

- 51 W x 32 D x 22 H cm (20 x 12-1/2 x 8-5/8 in.)
- Aluminum carry handle
- Heavy duty steel latches
- Lift-out carry tray



Case Pack	Case Weight	Case Size	20' FCL	40' FCL	40' HQ
2	6.4 kg (14 lbs.)	53 x 33 x 44 cm (20-7/8 x 13 x 17-1/4 in.)	770	1,580	1,896



Tools & accessories not included





320332 44 cm (17-1/2 in.) Power Tool Plastic Box

- 44 W x 33.5 D x 21 H cm (17-1/2 x 13-1/8 x 8-1/4 in.)
- Aluminum carry handle
- Heavy duty steel latches
- Lift-out carry tray
- Built-in storage compartments
- Extra depth: Increased storage capacity



Case Pack	Case Weight	Case Size	20' FCL	40' FCL	40' HQ
4	9.2 kg (20.3 lbs.)	46 x 37 x 87 cm (18-1/8 x 14-1/2 x 34-1/4 in.)	768	1,608	1,944



Tools not included



Tools & assortments not included



320316 53.5 cm (21 in.) Tool Box

- 53.5 W x 27.5 D x 24.7 H cm (21 x 10-3/4 x 9-3/4 in.)
- Aluminum comfort-grip top handle
- Heavy duty steel latches
- Lift-out carry tray



Case Pack	Case Weight	Case Size	20' FCL	40' FCL	40' HQ
5	12.9 kg (28.4 lbs.)	57 x 57 x 43 cm (22-1/2 x 22-1/2 x 17 in.)	1,000	2,100	2,520



320312 66 cm (26 in.) Tool Box with Organizers

- 66 W x 30.5 D x 28.3 H cm (26 x 12 x 11-1/8 in.)
- Professional grade construction
- Full length aluminum handle
- Two removable organizers
- Lift out carry tray
- Two interactive aluminum latches



Case Pack	Case Weight	Case Size	20' FCL	40' FCL	40' HQ
1	5 kg (11 lbs.)	68 x 32 x 30 cm (26-3/4 x 12-5/8 x 11-7/8 in.)	427	882	1,008



TPR rubber grip feet for anti-shock



2 pc aluminum interactive latches



Two removable organizers (23.5 x 19 x 4 cm)



320336 61 cm (24 in.) 2 in 1 Plastic Tool Box

- 61 W x 32.5 D x 28.5 H cm (24 x 12-3/4 x 11-1/4 in.)
- Lift-off carry case + deep storage tote
- Heavy duty steel latches
- Aluminum handle
- 3 x Removable dividers / internal organizational compartment



Case Pack	Case Weight	Case Size	20' FCL	40' FCL	40' HQ
1	4.2 kg (9.3 lbs.)	68 x 36 x 32 cm (26-3/4 x 14-1/8 x 12-5/8 in.)	357	735	840



Tools & assortments not included



PLASTIC TOOL BOX

320340 58.5 cm (23 in.) Heavy Duty Plastic Box

- 58.5 W x 31 D x 28 H cm (23 x 12-1/8 x 11 in.)
- Lift-off carry tray with two removable trays
- Heavy duty metal latch
- Aluminum carry handle



Case Pack	Case Weight	Case Size	20' FCL	40' FCL	40' HQ
1	4.5 kg (10 lbs.)	61 x 32 x 30 cm (24 x 12-5/8 x 11-3/4 in.)	462	952	1,088



Tools & assortments not included



320348 51 cm (20 in.) Tool Box with Side Organizers

- 51 W x 23 D x 21 H cm (20 x 9 x 8-1/4 in.)
- Orange PP tray inside
- 2 Side removable organizers
- 2 Heavy-duty steel latches
- Aluminum comfort-grip top handle



Case Pack	Case Weight	Case Size	20' FCL	40' FCL	40' HQ
4	10.2 kg (22.5 lbs.)	53 x 51 x 46 cm (20-7/8 x 20 x 18-1/8 in.)	880	1,840	2,240



320350 47 cm (18-1/2 in.) Cantilever Tool Box

- 47 W x 23 D x 24.5 H cm (18-1/2 x 9 x 9-5/8 in.)
- 2 Black PP trays inside
- 18pc Removable dividers to customize compartments
- Cantilever function
- One big container at bottom



Case Pack	Case Weight	Case Size	20' FCL	40' FCL	40' HQ
4	10.7 kg (23.6 lbs.)	49 x 48 x 51 cm (19-1/4 x 18-7/8 x 20 in.)	768	1,600	2,000



320380 48 cm (19 in.) Heavy Duty Tool Box

- 48 W x 27.5 D x 20.5 H cm (19 x 11 x 8 in.)
- Stack multiple units
- Cam-action ABS latches
- Soft-grip carry handle
- Lift-out tray with removable dividers
- Weather-proof rear hinge
- Lockable



Case Pack	Case Weight	Case Size	20' FCL	40' FCL
4	10.2 kg (22.5 lbs.)	57 x 51 x 44 cm (22-1/2 x 20 x 17-1/2 in.)	880	1,840



Tools & accessories not included





320064 52.5 cm (20-1/2 in.) Technician Tool Case

- 52.5 W x 38.9 D x 19 H cm (20-1/2 x 15-1/4 x 7-1/2 in.)
- Integrated flexible shock-absorbing inlay for tool protection
- 2pc Removeable organizers on lid for frequently used accessories
- Removeable dividers inside



Inner Pack	Case Pack	Case Weight	Case Size	20' FCL	40' FCL
0	4	16 kg (35 lbs.)	55 x 41 x 78 cm (21-5/8 x 16-1/8 x 30-3/4 in.)	672	1,392



Accessories not included



320390 53.5 cm (21 in.) Structural Foam Tool Box

- 53.5 W x 28.8 D x 25.4 H cm (21 x 11-3/8 x 10 in.)
- Extra heavy duty, professional tool box
- Weather seal makes toolbox weather resistant



IP53



Case Pack	Case Weight	Case Size	20' FCL	40' FCL
4	13.8 kg (30.4 lbs.)	60 x 56 x 54 cm (23-5/8 x 22 x 21-1/4 in.)	608	1,312



Tools & accessories not included



320392 66.2 cm (26 in.) Structural Foam Tool Box

- 66.2 W x 33.4 D x 29 H cm (26 x 13-1/8 x 11-1/2 in.)
- Extra heavy duty, professional tool box
- Weather seal makes toolbox weather resistant



IP53



Case Pack	Case Weight	Case Size	20' FCL	40' FCL	40' HQ
4	20.2 kg (44.5 lbs.)	69 x 69 x 60.5 cm (27-1/8 x 27-1/8 x 23-3/4 in.)	288	612	816



320394 71.2 cm (28 in.) Structural Foam Rolling Box

- 71.2 W x 33.6 D x 30 H cm (28 x 13-1/4 x 11-3/4 in.) without castor
- Extra heavy duty, professional tool box
- Weather seal makes toolbox weather resistant
- Large rubber coated 15 x 5 cm (6 x 2 in.) wheels (TPR)
- Pull out steel handle



IP53



Case Pack	Case Weight	Case Size	20' FCL	40' FCL
10	68 kg (150 lbs.)	76 x 70 x 97 cm (30 x 27-1/2 x 38-1/8 in.)	480	1020



WEATHER-PROOF PROTECTIVE STORAGE

(Contents not included)

TOUGH CASE



Heavy-duty Handle

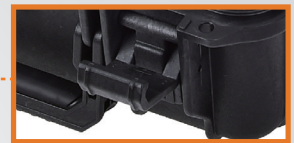

Cam-action Latches



Two Padlockable Hasps



Auto Pressure Equalization Valve

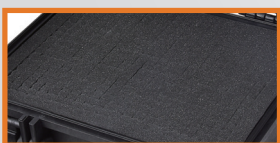

Pick & Pull Foam



Weather & Dust Proof





320082 Tough Case - S

- 23.5 W x 19 D x 11.2 H cm (9-1/4 x 7-1/2 x 4-3/8 in.)
- Pick-and-pull foam insert for impact-absorbing protection
- Strong, secure, easy-open latches
- Automatic pressure relief valve equalizes pressure for easy opening
- Pre-drilled for two padlocks (locks not included)
- Super strong reinforced polypropylene construction



Case Pack	Case Weight	Case Size	20' FCL	40' FCL	40' HQ
12	9.3 kg (20.5 lbs.)	49.5 x 40.5 x 37.5 cm (19-3/8 x 15-7/8 x 14-3/4 in.)	4,608	9,720	11,340



Contents not included



320084 Tough Case - M

- 34.5 W x 29.5 D x 15.4 H cm (13-1/2 x 11-5/8 x 6 in.)
- Pick-and-pull foam insert for impact-absorbing protection
- Strong, secure, easy-open latches
- Automatic pressure relief valve equalizes pressure for easy opening
- Pre-drilled for two padlocks (locks not included)
- Super strong reinforced polypropylene construction



Case Pack	Case Weight	Case Size	20' FCL	40' FCL	40' HQ
6	11.5 kg (25 lbs.)	62.5 x 37 x 49 cm (24-1/2 x 14-1/2 x 19-1/4 in.)	1,320	2,760	3,450



Contents not included



320086 Tough Case - L

- 41.5 W x 32.5 D x 18.2 H cm (16-1/4 x 12-3/4 x 7-1/8 in.)
- Pick-and-pull foam insert for impact-absorbing protection
- Strong, secure, easy-open latches
- Automatic pressure relief valve equalizes pressure for easy opening
- Pre-drilled for two padlocks (locks not included)
- Super strong reinforced polypropylene construction



Case Pack	Case Weight	Case Size	20' FCL	40' FCL	40' HQ
2	5.8 kg (13 lbs.)	43.5 x 35 x 39.5 cm (17-1/8 x 13-3/4 x 15-1/2 in.)	930	1,910	2,292



Contents not included

PLASTIC TOOL BOX



320087 Tough Case - XL

- 54.4 x 43.6 x 21.6 cm (21-3/8 x 17-1/8 x 8-1/2 in.)
- Heavy-duty latches and handle
- Pick-and-pull foam insert for maximum impact-absorbing protection and customization
- Automatic pressure relief valve equalizes pressure for easy opening
- Pre-drilled for two padlocks (locks not included)
- Super strong reinforced polypropylene construction

NEW



IP65



6 970834 677461



Case Pack	Case Weight	Case Size	20' FCL	40' FCL
2	9.9 kg (21.78 lbs.)	57 x 46 x 46 cm (22-3/8 x 18-1/8 x 18-1/8 in.)	510	1,050

320088 Tough Case - Rolling

- 55.8 x 35.2 x 23.2 cm (22 x 13-3/4 x 9-1/8 in.)
- Heavy-duty latches and handle
- Super strong reinforced polypropylene construction
- Rolling tough case with heavy-duty wheel

NEW



IP65



6 970834 677478



Case Pack	Case Weight	Case Size	20' FCL	40' FCL	40' HQ
2	12.5 kg (27.5 lbs.)	58 x 37 x 47.5 cm (22-3/4 x 14-1/2 x 18-5/8 in.)	496	1,024	1,280



Automatic pressure relief valve



Pre-drilled for two padlocks



Include smooth rolling casters (x 2)



Fits most airline size requirements



Contents not included



Flexible telescope handle

COLORFUL TOUGH CASE

WEATHER & DUST RESISTANT IP65 RATED



YELLOW



ORANGE



GREEN



TAN



Heavy-duty Handle



Two Padlockable Hasps

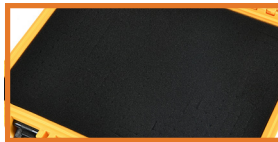

Pick & Pull Foam



Cam-action Latches



Auto Pressure Equalization Valve



IP65



(Contents not included)

NEW

- Pick-and-pull foam insert for impact-absorbing protection
- Strong, secure, easy-open latches
- Automatic pressure relief valve equalizes pressure for easy opening
- Pre-drilled for two padlocks (locks not included)
- Super strong reinforced polypropylene construction

Item No.	Dimension	Case Pack	Case Weight	Case Size	20' FCL	40' FCL	40' HQ
320082C	23.5 W x 19 D x 11.2 H cm (9-1/4 x 7-1/2 x 4-3/8 in.)	12	9.3 kg (20.5 lbs.)	49.5 x 40.5 x 37.5 cm (19-3/8 x 15-7/8 x 14-3/4 in.)	4,608	9,720	11,340
320084C	34.5 W x 29.5 D x 15.4 H cm (13-1/2 x 11-5/8 x 6 in.)	6	11.5 kg (25 lbs.)	62.5 x 37 x 49 cm (24-1/2 x 14-1/2 x 19-1/4 in.)	1,320	2,760	3,450
320086C	41.5 W x 32.5 D x 18.2 H cm (16-1/4 x 12-3/4 x 7-1/8 in.)	2	5.8 kg (13 lbs.)	43.5 x 35 x 39.5 cm (17-1/8 x 13-3/4 x 15-1/2 in.)	930	1,910	2,292

PLASTIC & METAL TOOL STORAGE

HEAVY
DUTY
STORAGE
SOLUTION



- A** 321108 58.5 cm (23 in.) Plastic & Metal Tool Box
- B** 321120 60.3 cm (24 in.) Plastic & Metal Rolling Tool Box
- C** 321121 50 cm (20 in.) Plastic & Metal Tool Box
- D** 321122 65 cm (26 in.) Plastic & Metal Tool Box
- B&C** 321123 2 in 1 Plastic & Metal Rolling Tool Box Set
- E** 321118 58.5 cm (23 in.) Plastic & Stainless Steel Tool Box
- F** 321130 60.3 cm (24 in.) Plastic & Stainless Steel Rolling Tool Box
- G** 321131 50 cm (20 in.) Plastic & Stainless Steel Tool Box
- H** 321132 65 cm (26 in.) Plastic & Stainless Steel Tool Box
- F&G** 321133 2 in 1 Plastic & Stainless Steel Rolling Tool Box Set



321121 50 cm (20 in.) Plastic & Metal Tool Box

- 50 W x 23.3 D x 23.2 H cm (20 x 9-1/8 x 9-1/8 in.)
- Heavy duty steel latches
- Aluminum carry handle
- Lift-out carry tray inside



Case Pack	Case Weight	Case Size	20' FCL	40' FCL
4	11 kg (24 lbs.)	51 x 47 x 48 cm (20 x 18-1/2 x 18-7/8 in.)	768	1,600



321122 65 cm (26 in.) Plastic & Metal Tool Box

- 65 W x 27.6 D x 26.2 H cm (26 x 10-7/8 x 10-1/4 in.)
- Heavy duty steel latches
- Aluminum carry handle
- Lift-out carry tray



Case Pack	Case Weight	Case Size	20' FCL	40' FCL
4	17 kg (37 lbs.)	66 x 56.5 x 54 cm (26 x 22-1/4 x 21-1/4 in.)	560	1,152



321120 60.3 cm (24 in.) Plastic & Metal Rolling Tool Box

- 60.3 W x 36.5 D x 39 H cm (24 x 14-3/8 x 15-3/8 in.) without castor
- Heavy duty steel latches
- Lift-out carry tray inside
- Large rubber coated (150 x 40mm) wheels
- Telescopic extension handle



Case Pack	Case Weight	Case Size	20' FCL	40' FCL
2	14.4 kg (32 lbs.)	62 x 40 x 80 cm (24-3/8 x 15-3/4 x 31-1/2 in.)	208	436



Tools & accessories not included



321123 2 in 1 Rolling Tool Box Set

- Two well-built storage boxes
- Small box Size: 50 W x 23.3 D x 23.2 H cm (20 x 9-1/8 x 9-1/8 in.)
- Rolling box Size: 60.3 W x 36.5 D x 39 H cm (24 x 14-3/8 x 15-3/8 in.) without castor
- Heavy duty steel latches
- Aluminum carry handle
- 2 x Lift-out carry trays
- Telescopic extension handle
- Large rubber coated (150 x 40mm) wheels



Case Pack	Case Weight	Case Size	20' FCL	40' FCL
1	10.1 kg (22 lbs.)	62 x 37 x 45 cm (24-3/8 x 14-1/2 x 17-5/8 in.)	280	580



Tools & accessories not included

PLASTIC TOOL BOX

321131 50 cm (20 in.) Plastic & Stainless Steel Tool Box

- 50 W x 23.3 D x 23.2 H cm (20 x 9-1/8 x 9-1/8 in.)
- Heavy duty steel latches
- Aluminum carry handle
- Lift-out carry tray inside



Case Pack	Case Weight	Case Size	20' FCL	40' FCL
4	11 kg (24 lbs.)	51 x 47 x 48 cm (20 x 18-1/2 x 18-7/8 in.)	768	1,600



321132 65 cm (26 in.) Plastic & Stainless Steel Tool Box

- 65 W x 27.6 D x 26.2 H cm (26 x 10-7/8 x 10-1/4 in.)
- Heavy duty steel latches
- Aluminum carry handle
- Lift-out carry tray



Case Pack	Case Weight	Case Size	20' FCL	40' FCL
4	17 kg (37 lbs.)	66 x 56.5 x 54 cm (26 x 22-1/4 x 21-1/4 in.)	560	1,152



321130 60.3 cm (24 in.) Plastic & Stainless Steel Rolling Tool Box

- 60.3 W x 36.5 D x 39 H cm (24 x 14-3/8 x 15-3/8 in.) without castor
- Heavy duty steel latches
- Lift-out carry tray inside
- Large rubber coated (150 x 40mm) wheels
- Telescopic extension handle



Case Pack	Case Weight	Case Size	20' FCL	40' FCL
2	14.4 kg (32 lbs.)	62 x 40 x 80 cm (24-3/8 x 15-3/4 x 31-1/2 in.)	208	436



Tools & accessories not included

321133 2 in 1 Rolling Tool Box Set

- Two well-built storage boxes
- Small box Size: 50 W x 23.3 D x 23.2 H cm (20 x 9-1/8 x 9-1/8 in.)
Rolling box Size: 60.3 W x 36.5 D x 39 H cm (24 x 14-3/8 x 15-3/8 in.) without castor
- Heavy duty steel latches
- Aluminum carry handle
- 2 x Lift-out carry trays
- Telescopic extension handle
- Large rubber coated (150 x 40mm) wheels



Case Pack	Case Weight	Case Size	20' FCL	40' FCL
1	10.1 kg (22 lbs.)	62 x 37 x 45 cm (24-3/8 x 14-1/2 x 17-5/8 in.)	280	580

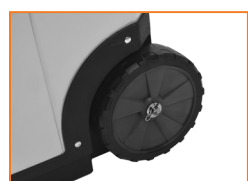

Tools & accessories not included



321108 58.5 cm (23 in.) Plastic & Metal Tool Box

- 58.5 W x 28.8 D x 25.5 H cm (23 x 11-3/8 x 10 in.)
- Heavy duty steel latches
- Full length aluminum handle
- Removable tubs inside
- Lift-out carry tray



Case Pack	Case Weight	Case Size	20' FCL	40' FCL
4	18.4 kg (41 lbs.)	60 x 60 x 54 cm (23-5/8 x 23-5/8 x 21-1/4 in.)	432	960



Tools & assortments not included



321118 58.5 cm (23 in.) Plastic & Stainless Steel Tool Box

- 58.5 W x 28.8 D x 25.5 H cm (23 x 11-3/8 x 10 in.)
- Heavy duty steel latches
- Full length aluminum handle
- Removable tubs inside
- Lift-out carry tray



Case Pack	Case Weight	Case Size	20' FCL	40' FCL
4	18.4 kg (41 lbs.)	60 x 60 x 54 cm (23-5/8 x 23-5/8 x 21-1/4 in.)	432	960



320322 51 cm (20 in.) Plastic and Metal Tool Box

- 51 W x 30 D x 26.5 H cm (20 x 11-3/4 x 10-3/8 in.)
- Steel latches for durability
- Full length aluminum handle



Case Pack	Case Weight	Case Size	20' FCL	40' FCL	40' HQ
1	4.4 kg (10 lbs.)	52 x 32 x 29 cm (20-1/2 x 12-5/8 x 11-3/8 in.)	640	1,328	1,494



320324 62 cm (24-1/2 in.) Plastic and Metal Tool Box

- 62 W x 29.5 D x 26.5 H cm (24-1/2 x 11-5/8 x 10-3/8 in.)
- Steel latches for durability
- Full length aluminum handle
- 2pc Removable organizers - 23.5 W x 19 D x 5.5 H cm (9-1/4 x 7-1/2 x 2-1/8 in.)



Case Pack	Case Weight	Case Size	20' FCL	40' FCL	40' HQ
1	5.5 kg (12 lbs.)	65 x 33 x 30 cm (25-1/2 x 13 x 11-3/4 in.)	441	882	1,008

HEAVY DUTY STORAGE BOX



30 L



320500 30 L Container Box

- 40.8 W x 38.3 D x 32.5 H cm (16 x 15 x 12-3/4 in.)
- Sturdy structural construction
- Can be stackable
- 4 x Soft feet
- Easy to open strong, durable metal latch
- Ideal for storage of large items, tools and accessories

320500

320504



Case Pack	Case Weight	Case Size	20' FCL	40' FCL	40' HQ
10	21.9 kg (48.3 lbs.)	45 x 57 x 83 cm (17-3/4 x 22-1/2 x 32-5/8 in.)	1,400	2,800	3,180

45 L



320502 45 L Container Box

- 60.5 W x 38.3 D x 32.5 H cm (23-3/4 x 15 x 12-3/4 in.)
- Sturdy structural construction
- Can be stackable
- 4 x Soft feet with wheel assemble hole
- Easy to open strong, durable metal latch
- Ideal for storage of large items, tools and accessories

320502

320508



Case Pack	Case Weight	Case Size	20' FCL	40' FCL	40' HQ
10	31.2 kg (68.8 lbs.)	63 x 57 x 83 cm (24-3/4 x 22-1/2 x 32-5/8 in.)	1,000	2,080	2,280

60 L



320504 60 L Container Box

- 80.1 W x 38.3 D x 32.5 H cm (31-1/2 x 15 x 12-3/4 in.)
- Sturdy structural construction
- Can be stackable
- 4 x Soft feet with wheel assemble hole
- Easy to open strong, durable metal latch
- Ideal for storage of large items, tools and accessories

320500

320504



Case Pack	Case Weight	Case Size	20' FCL	40' FCL	40' HQ
10	40.8 kg (90 lbs.)	84 x 57 x 83 cm (33 x 22-1/2 x 32-5/8 in.)	560	1,120	1,680

85 L



320506 85 L Container Box

- 85 W x 49 D x 39 H cm (33-1/2 x 19-1/4 x 15-3/8 in.)
- Sturdy structural construction
- Can be stackable
- 4 x Soft feet with wheel assemble hole
- Easy to open strong, durable metal latch
- Ideal for storage of large items, tools and accessories



Case Pack	Case Weight	Case Size	20' FCL	40' FCL
6	30.1 kg (66.4 lbs.)	87 x 53 x 98 cm (34-1/4 x 20-7/8 x 38-5/8 in.)	336	696

PLASTIC TOOL BOX



135 L

320508 135 L Container Box

- 85 W x 61 D x 45 H cm (33-1/2 x 24 x 17-3/4 in.)
- Sturdy structural construction
- Can be stackable
- 4 x Soft feet with wheel assemble hole
- Easy to open strong, durable metal latch
- Ideal for storage of large items, tools and accessories



Case Pack	Case Weight	Case Size	20' FCL	40' FCL
6	40.5 kg (89.3 lbs.)	87 x 64 x 103 cm (34-1/4 x 25-1/4 x 40-1/2 in.)	264	540

320520 4PC 2 x 1 in. Container Box Castor Set

- Size: 2 x 1 in.
- Wheels allow for easy mobility of Tactix container box
- Loading capacity: 40 kg each



Case Pack	Case Weight	Case Size	20' FCL	40' FCL	40' HQ
10	10.9 kg (24 lbs.)	49 x 25.5 x 30.5 cm (19-1/4 x 10 x 12 in.)	8,080	16,800	18,950



Castor with brake

320530 100L Heavy Duty Cargo Case

- 89.5 W x 45.5 D x 35.5 H cm (35-1/4 x 18 x 14 in.)
- Weather & dust resistance
- Carry handle with comfort grips
- Stack multiple units with interlocking feet
- PU bearing wheels
- Secure latching system
- Padlock provision



Tools & assortments not included



Case Pack	Case Weight	Case Size	20' FCL	40' FCL	40' HQ
1	8.5 kg (19 lbs.)	91 x 47 x 38 cm (35-3/4 x 18-1/2 x 15 in.)	180	360	408





320310 2 in 1 Rolling Tool Box

- Top size: 50.8 W x 26 D x 23 H cm (20 x 10-1/8 x 9 in.)
- Bottom size: 61 W x 37 D x 37 H cm (24 x 14-1/2 x 14-1/2 in.) without castor
- Two well-built storage boxes
- Large rubber coated 15 x 5 cm (6 x 2 in.) wheels (TPR)
- Carried tray in top tool box
- Heavy duty steel latches



Case Pack	Case Weight	Case Size	20' FCL	40' FCL	40' HQ
1	6.6 kg (14.6 lbs.)	63 x 39 x 40 cm (24-3/4 x 15-3/8 x 15-3/4 in.)	270	550	660



Built in V-groove with SAE & Metric measuring increments



Pull out steel handle



320310B 61 cm (24 in.) Mobile Tool Box

- 61 W x 37 D x 37 H cm (24 x 14-1/2 x 14-1/2 in.) without castor
- Large rubber coated (6 x 2 in) wheels (TPR)
- Heavy duty steel latches
- Pull out steel handle



Case Pack	Case Weight	Case Size	20' FCL	40' FCL
6	19.6 kg (43 lbs.)	63 x 41 x 108 cm (24-3/4 x 16-1/8 x 42-1/2 in.)	612	1,272



320302 64.2 cm (25-1/4 in.) Mobile Tool Box

- 64.2 W x 38.3 D x 41 H cm (25-1/4 x 15 x 16-1/8 in.) without castor
- Telescopic handle extends to 90 cm (35-1/2 in.) high
- Heavy duty plastic / rubber wheels 15 x 4 cm (6 x 1-1/2 in.)



Case Pack	Case Weight	Case Size	20' FCL	40' FCL	40' HQ
1	9.5 kg (21 lbs.)	70 x 40 x 51 cm (27-1/2 x 15-3/4 x 20 in.)	184	388	485



TPR rubber grip feet for anti-shock



Locking feature



Strong, durable side handles



320308 2 in 1 Rolling Tool Box

- Top size: 56 W x 28 D x 25 H cm (22 x 11 x 9-5/8 in.); Bottom size: 64.2 W x 38.3 D x 41 H cm (25-1/4 x 15 x 16-1/8 in.) without castor
- Two well built storage boxes
- Built-in / lift-out organizer
- Heavy duty steel latches
- 320302 + 320304



Case Pack	Case Weight	Case Size	20' FCL	40' FCL	40' HQ
1	12.9 kg (28 lbs.)	70 x 40 x 51 cm (27-1/2 x 15-3/4 x 20 in.)	184	388	485



Heavy duty plastic / rubber wheels 15 x 4 cm (6 x 1-1/2 in.)



Locking feature



Strong, durable side handles



TPR rubber grip feet for anti-shock

PLASTIC TOOL BOX



Tools not included

320314 75.5 cm (29 in.) Mobile Tool Box

- 75.5 W x 47 D x 48.5 H cm (29 x 18-1/2 x 19 in.) without castor
- Full size tote tray with built in compartments
- Large rubber coated 15 x 5 cm (6 x 2 in.) wheels
- Easy to open strong, durable metal latch
- Sturdy structural construction won't dent, rust, chip or peel



Tools not included



Case Pack	Case Weight	Case Size	20' FCL	40' FCL
10 (without pallet)	93 kg (205 lbs.)	98 x 77 x 109 cm (38-1/2 x 30-1/2 x 43 in.)	340	720



HEAVY DUTY MODULAR TOOL STORAGE SYSTEM



Tools & accessories not included



PLASTIC TOOL BOX

NEW

320369 12-Compartment Organizer

- 52.8 W x 36.8 D x 12.9 H cm (20-3/4 x 14-3/8 x 5 in.)
- Seal for weather proof
- 8x Small bins and 2x big bins with dividers inside
- 2x Metal latches & 1x Plastic handle
- Made by PP body and PC lid
- 2x Side latches ; Can be interlocked with any HD Modular System boxes to create a storage solution for any need



Case Pack	Case Weight	Case Size	20' FCL	40' FCL	40' HQ
4	13.7 kg (30.1 lbs.)	55 x 39 x 53 cm (21-5/8 x 15-1/4 x 20-3/4 in.)	976	2,000	2,500

320360 Portable Technician Case

- 52.8 W x 37.1 D x 17.9 H cm (20-3/4 x 14-1/2 x 7 in.)



Customize storage with removable storage boxes (x6)



Case Pack	Case Weight	Case Size	20' FCL	40' FCL
4	17.9 kg (39 lbs.)	54 x 38.5 x 72.8 cm (21-1/4 x 15-1/8 x 28-1/2 in.)	720	1,584

320361 Deep Tool Chest

- 52.8 W x 37.1 D x 31 H cm (20-3/4 x 14-1/2 x 12-1/8 in.)



Lift-out tool organizers (x2)



Case Pack	Case Weight	Case Size	20' FCL	40' FCL
2	10.7 kg (24 lbs.)	54 x 38.5 x 64 cm (21-1/4 x 15-1/8 x 25-1/4 in.)	360	792

320362 2 Drawers Tool Chest

- 52.8 W x 37.1 D x 39.9 H cm (20-3/4 x 14-1/2 x 15-3/4 in.)



Drawers with dividers (x2) to store all your tools and accessories



Case Pack	Case Weight	Case Size	20' FCL	40' FCL
1	8.8 kg (19 lbs.)	54 x 38.5 x 42 cm (21-1/4 x 15-1/8 x 16-1/2 in.)	300	660



320370 HD Modular System - Basket

- 52.6 W x 34.4 D x 25.3 H cm (20-5/8 x 13-1/2 x 9-7/8 in.)

NEW



Large storage room to store more power tools and accessories



Case Pack	Case Weight	Case Size	20' FCL	40' FCL	40' HQ
2	5.1 kg (11.2 lbs.)	54.5 x 39 x 53.5 cm (21-3/8 x 15-3/4 x 21 in.)	496	1,008	1,000



320365 Mobile Tool Chest

- 56.2 W x 37.4 D x 41.2 H cm (22-1/8 x 14-5/8 x 16-1/8 in.) without castor



Telescopic extension handle & lift-out carry tray



Case Pack	Case Weight	Case Size	20' FCL	40' FCL	40' HQ
2	18.9 kg (42 lbs.)	59 x 57 x 85 cm (23-1/4 x 22-3/8 x 33-1/2 in.)	208	432	496



320364 Tool Storage Transport Trolley

- 100 W x 61.5 D x 46 H cm/folded(39-3/8 x 24-1/4 x 18 in.)



Case Pack	Case Weight	Case Size	20' FCL	40' FCL
1	11.6 kg (26 lbs.)	104 x 64 x 23 cm (41 x 25-1/4 x 9 in.)	180	360



Mobile Storage - Tool boxes link onto the trolley for transportation or use the trolley to shift bulky loads
Tool boxes (320360, 320361, 320362) sold separately

PLASTIC TOOL BOX

320366 4PC Heavy Duty Modular Tool Storage System



Case Pack	Case Weight	Case Size	20' FCL	40' FCL
1	30.6 kg (67 lbs.)	63 x 55 x 105 cm (24-3/4 x 21-1/2 x 41-1/4 in.)	74	156



Tools & contents not included



320360

320361

320362

320367 3PC Heavy Duty Modular Tool Storage System



Case Pack	Case Weight	Case Size	20' FCL	40' FCL
1	22.9 kg (50 lbs.)	60 x 47 x 103 cm (23-5/8 x 18-1/2 x 40-1/2 in.)	90	190



Tools & contents not included



320360

320362

320365

320368 3PC Heavy Duty Modular Tool Storage System



Case Pack	Case Weight	Case Size	20' FCL	40' FCL
1	19.3 kg (43 lbs.)	60 x 47 x 94 cm (23-5/8 x 18-1/2 x 37 in.)	90	190



Tools & contents not included



320360

320361

320365

CUSTOMIZE

YOUR MODULAR STORAGE SYSTEM



320002 5-Compartment Storage Box

- 19 W x 11.5 D x 3 H cm (7-1/2 x 4-1/2 x 1-1/8 in.)
- 5 Compartments
- Removable dividers



Inner Pack	Case Pack	Case Weight	Case Size	20' FCL	40' FCL	40' HQ
12	36	4.2 kg (9.3 lbs.)	28 x 22 x 61 cm (11 x 8-5/8 x 24 in.)	30,240	63,360	71,280



320003 6-Compartment Storage Box

- 19.5 W x 16 D x 5 H cm (7-3/4 x 6-1/4 x 2 in.)
- 6 Compartments
- Removable dividers

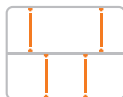

Inner Pack	Case Pack	Case Weight	Case Size	20' FCL	40' FCL	40' HQ
12	24	4.9 kg (10.8 lbs.)	35 x 32 x 43 cm (13-3/4 x 12-1/2 x 17 in.)	14,160	29,280	35,136



320004 14-Compartment Storage Box

- 19.5 W x 16 D x 5 H cm (7-3/4 x 6-1/4 x 2 in.)
- 14 Compartments
- Removable dividers

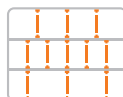

Inner Pack	Case Pack	Case Weight	Case Size	20' FCL	40' FCL	40' HQ
12	24	5.7 kg (12.6 lbs.)	35 x 32 x 43 cm (13-3/4 x 12-1/2 x 17 in.)	14,160	29,280	35,136



320005 1-Compartment Storage Box

- 19.5 W x 16 D x 5 H cm (7-3/4 x 6-1/4 x 2 in.)



Inner Pack	Case Pack	Case Weight	Case Size	20' FCL	40' FCL	40' HQ
12	24	4.4 kg (10.7 lbs.)	35 x 32 x 43 cm (13-3/4 x 12-1/2 x 17 in.)	14,160	29,280	35,136



320006 18-Compartment Storage Box

- 31 W x 20 D x 5 H cm (12-1/4 x 7-7/8 x 2 in.)
- 18 Compartments
- Removable dividers



Inner Pack	Case Pack	Case Weight	Case Size	20' FCL	40' FCL	40' HQ
0	12	5.7 kg (12.6 lbs.)	66 x 32 x 22 cm (26 x 12-1/2 x 8-5/8 in.)	7,440	15,480	18,576



320007 12-Compartment Storage Box

- 31 W x 20 D x 5 H cm (12-1/4 x 7-7/8 x 2 in.)
- 12 Compartments
- Removable dividers



Inner Pack	Case Pack	Case Weight	Case Size	20' FCL	40' FCL	40' HQ
0	12	5.4 kg (12 lbs.)	66 x 32 x 22 cm (26 x 12-1/2 x 8-5/8 in.)	7,440	15,480	18,576



320008 3-Compartment Storage Box

- 31 W x 20 D x 8 H cm (12-1/4 x 7-7/8 x 3-1/8 in.)
- 3 Compartments
- Removable dividers



Inner Pack	Case Pack	Case Weight	Case Size	20' FCL	40' FCL	40' HQ
0	6	3 kg (6.6 lbs.)	51 x 35 x 22 cm (20 x 13-3/4 x 8-5/8 in.)	4,320	9,000	10,800

320009 6-Compartment Storage Box

- 31 W x 20 D x 8 H cm (12-1/4 x 7-7/8 x 3-1/8 in.)
- 6 Compartments
- Removable dividers

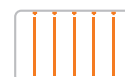

Inner Pack	Case Pack	Case Weight	Case Size	20' FCL	40' FCL	40' HQ
0	6	3.4 kg (7.5 lbs.)	51 x 35 x 22 cm (20 x 13-3/4 x 8-5/8 in.)	4,320	9,000	10,800

320010 3 PC Storage Box Set

- 19 W x 11.5 D x 3 H cm (7-1/2 x 4-1/2 x 1-1/8 in.)
- 31 W x 20 D x 8 H cm (12-1/4 x 7-7/8 x 3-1/8 in.)
- 2pc - 5 Compartments (S)
- 1pc - 6 Compartments (XL)
- Removable dividers



Inner Pack	Case Pack	Case Weight	Case Size	20' FCL	40' FCL	40' HQ
0	6	4.7 kg (10.4 lbs.)	51 x 35 x 22 cm (20 x 13-3/4 x 8-5/8 in.)	4,320	9,000	10,800

320011 2 PC Storage Box Set

- 19 W x 11.5 D x 3 H cm (7-1/2 x 4-1/2 x 1-3/16 in.)
- 31 W x 20 D x 5 H cm (12-1/4 x 7-7/8 x 2 in.)
- 1pc - 5 Compartments (S)
- 1pc - 18 Compartments (L)
- Removable dividers

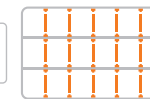

Inner Pack	Case Pack	Case Weight	Case Size	20' FCL	40' FCL	40' HQ
0	12	7.7 kg (17 lbs.)	66 x 32 x 22 cm (26 x 12-1/2 x 8-5/8 in.)	7,440	15,480	18,576

320030 8-Compartment Storage Box

- 35 W x 27 D x 9.5 H cm (13-3/4 x 10-5/8 x 3-3/4 in.)
- 8 Compartments

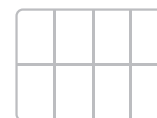

Inner Pack	Case Pack	Case Weight	Case Size	20' FCL	40' FCL	40' HQ
0	4	3.5 kg (7.7 lbs.)	40 x 42 x 30 cm (15-3/4 x 16-1/2 x 11-3/8 in.)	1,960	4,200	4,800

320032 20-Compartment Storage Box

- 35 W x 27 D x 5 H cm (13-3/4 x 10-5/8 x 2 in.)
- 20 Compartments
- Removable dividers

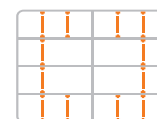

Inner Pack	Case Pack	Case Weight	Case Size	20' FCL	40' FCL	40' HQ
0	6	4.2 kg (9.3 lbs.)	39 x 34 x 30 cm (15-3/8 x 13-3/8 x 11-3/8 in.)	4,200	8,610	9,840

ORGANIZER

320016 19 cm (7-1/2 in.) Organizer

- 19 W x 15 D x 4 H cm (7-1/2 x 5-7/8 x 1-5/8 in.)
- 8 Compartments
- Removable dividers

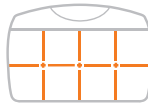

Inner Pack	Case Pack	Case Weight	Case Size	20' FCL	40' FCL	40' HQ
0	12	2.2 kg (5 lbs.)	42 x 29 x 18 cm (16-1/2 x 11-1/2 x 7 in.)	17,004	35,256	37,968



320017 25.5 cm (10 in.) Organizer

- 25.5 W x 21 D x 4 H cm (10 x 8-1/4 x 1-5/8 in.)
- 18 Compartments
- Removable dividers

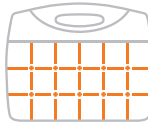

Inner Pack	Case Pack	Case Weight	Case Size	20' FCL	40' FCL	40' HQ
0	12	3.9 kg (8.6 lbs.)	54 x 30 x 24 cm (21-1/4 x 11-3/4 x 9-1/2 in.)	8,640	18,144	22,176



320018 31 cm (12-1/4 in.) Organizer

- 31 W x 24 D x 5 H cm (12-1/4 x 9-1/2 x 2 in.)
- 21 Compartments
- Removable dividers

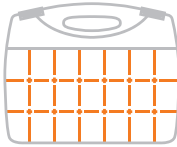

Inner Pack	Case Pack	Case Weight	Case Size	20' FCL	40' FCL	40' HQ
0	6	3.3 kg (7.3 lbs.)	35 x 35 x 26 cm (13-3/4 x 13-3/4 x 10-1/2 in.)	5,184	11,016	12,240



320001 38 cm (15 in.) Organizer

- 38 W x 31 D x 6 H cm (15 x 12 x 2-3/8 in.)
- 21 Compartments
- Removable dividers

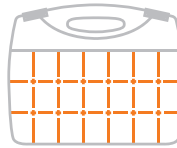

Inner Pack	Case Pack	Case Weight	Case Size	20' FCL	40' FCL	40' HQ
0	6	4.8 kg (10.6 lbs.)	42 x 41 x 34 cm (16-1/2 x 16-1/8 x 13-3/8 in.)	2,880	5,940	7,128



320019 3 PC Organizer Set

- 19 W x 15 D x 4 H cm (7-1/2 x 5-7/8 x 1-5/8 in.)
- 25.5 W x 21 D x 4 H cm (10 x 8-1/4 x 1-5/8 in.)
- 31 W x 24 D x 5 H cm (12-1/4 x 9-1/2 x 2 in.)
- 8 Compartments/ 18 compartments/ 21 compartments
- Removable dividers

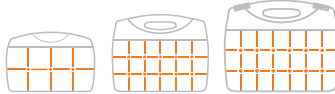

Inner Pack	Case Pack	Case Weight	Case Size	20' FCL	40' FCL	40' HQ
0	24	23.2 kg (51 lbs.)	59 x 51 x 81 cm (23-1/4 x 20 x 31-7/8 in.)	2,400	5,184	6,480





320016N 19 cm (7-1/2 in.) Organizer

- 19 W x 15 D x 4 H cm (7-1/2 x 5-7/8 x 1-5/8 in.)
- 8 Compartments
- Removable dividers



Case Pack	Case Weight	Case Size	20' FCL	40' FCL	40' HQ
12	2.2 kg (5 lbs.)	42 x 29 x 18 cm (16-1/2 x 11-1/2 x 7 in.)	17,004	35,256	37,968



320017N 25.5 cm (10 in.) Organizer

- 25.5 W x 21 D x 4 H cm (10 x 8-1/4 x 1-5/8 in.)
- 18 Compartments
- Removable dividers



Case Pack	Case Weight	Case Size	20' FCL	40' FCL	40' HQ
12	4 kg (8.8 lbs.)	54 x 30 x 24 cm (21-1/4 x 11-3/4 x 9-1/2 in.)	8,640	18,144	22,176



320018N 31 cm (12-1/4 in.) Organizer

- 31 W x 24 D x 5 H cm (12-1/4 x 9-1/2 x 2 in.)
- 21 Compartments
- Removable dividers

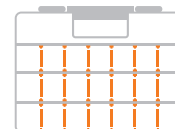

Case Pack	Case Weight	Case Size	20' FCL	40' FCL	40' HQ
6	3.2 kg (7 lbs.)	35 x 35 x 26 cm (13-3/4 x 13-3/4 x 10-1/2 in.)	5,184	11,016	12,240



320001N 38 cm (15 in.) Organizer

- 38 W x 31 D x 6 H cm (15 x 12 x 2-3/8 in.)
- 21 Compartments
- Removable dividers

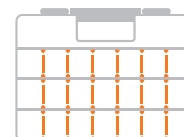

Case Pack	Case Weight	Case Size	20' FCL	40' FCL	40' HQ
6	4.9 kg (10.8 lbs.)	42 x 41 x 34 cm (16-1/2 x 16-1/8 x 13-3/8 in.)	2,880	5,940	7,128

ORGANIZER

320021 23 cm (9 in.) Thin Plastic Organizer

- 31 W x 23 D x 5.8 H cm (12-1/4 x 9 x 2-1/4 in.)
- Removable organizers
- Customizable compartments

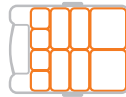

Inner Pack	Case Pack	Case Weight	Case Size	20' FCL	40' FCL	40' HQ
0	9	5.5 kg (12 lbs.)	54 x 24 x 34 cm (21-1/4 x 9-1/2 x 13-3/8 in.)	5,832	12,069	14,751

320022 15.6 cm (6-1/8 in.) Organizer-Thin

- 15.6 W x 22.8 D x 5.8 H cm (6-1/8 x 9 x 2-1/4 in.)
- Removable trays
- Customizable compartments
- Snap-shut latch

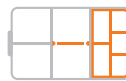

Inner Pack	Case Pack	Case Weight	Case Size	20' FCL	40' FCL
0	12	3 kg (7 lbs.)	33 x 25 x 38 cm (13 x 9-3/4 x 15 in.)	11,832	24,384

320023 23 cm (9 in.) Thick Plastic Organizer

- 31 W x 23 D x 11.7 H cm (12-1/4 x 9 x 4-1/2 in.)
- Removable organizers
- Customizable compartments

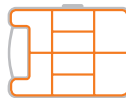

Inner Pack	Case Pack	Case Weight	Case Size	20' FCL	40' FCL
0	9	7 kg (15 lbs.)	69 x 33 x 38 cm (27 x 13 x 15 in.)	3,186	6,543

320024 15.6 cm (6-1/8 in.) Organizer-Thick

- 15.6 W x 22.8 D x 11.6 H cm (6-1/8 x 9 x 4-1/2 in.)
- Removable trays
- Customizable compartments
- Snap-shut latch



Inner Pack	Case Pack	Case Weight	Case Size	20' FCL	40' FCL
0	6	3.5 kg (8 lbs.)	31 x 25 x 38 cm (12-1/4 x 9-3/4 x 15 in.)	6,240	11,556



320026 29 cm (11-3/8 in.) Organizer-Thin

- 29 W x 22.8 D x 5.8 H cm (11-3/8 x 9 x 2-1/4 in.)
- Removable trays
- Customizable compartments
- Snap-shut latches

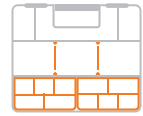

Inner Pack	Case Pack	Case Weight	Case Size	20' FCL	40' FCL	40' HQ
0	6	3.2 kg (7 lbs.)	31 x 26 x 38 cm (12-1/4 x 10-1/4 x 15 in.)	6,048	12,582	13,980



320020 4 in 1 Organizer

- 2pc - 15.6 W x 22.8 D x 5.8 H cm (6-1/8 x 9 x 2-1/4 in.)
- 1pc - 15.6 W x 22.8 D x 11.6 H cm (6-1/8 x 9 x 4-1/2 in.)
- 1pc - 29 W x 22.8 D x 5.8 H cm (11-3/8 x 9 x 2-1/4 in.)
- 4 Pack organizer set
- Removable trays
- Customizable compartments
- Snap-shut latches



Inner Pack	Case Pack	Case Weight	Case Size	20' FCL	40' FCL	40' HQ
0	20	28.7 kg (63.3 lbs.)	51 x 66 x 91 cm (20 x 26 x 35-3/4 in.)	1,600	3,520	4,400



320033 2 in 1 Organizer

- 2 Pack organizer set
- Removable trays
- Customizable compartments

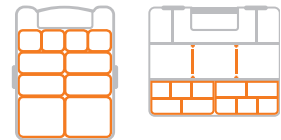

Inner Pack	Case Pack	Case Weight	Case Size	20' FCL	40' FCL
0	8	9 kg (20 lbs.)	48 x 33 x 73 cm (19 x 13 x 28-1/4 in.)	1,680	3,520



320038 6 in 1 Organizer

- 6 Pack organizer set
- Removable organizers
- Customizable compartments



Inner Pack	Case Pack	Case Weight	Case Size	20' FCL	40' FCL
0	4	11.1 kg (24.5 lbs.)	47 x 34 x 73 cm (18-1/2 x 13-3/8 x 28-3/4 in.)	984	2,040



320024



320022



320026



320023

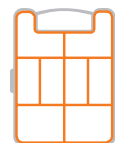

320021

ORGANIZER

320028 32 cm (12-1/2 in.) Double-sided Organizer

- 32 W x 27.2 D x 8 H cm (12-1/2 x 10-3/4 x 3-1/8 in.)
- Double sided
- Removable dividers to customize compartments

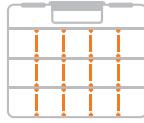

Inner Pack	Case Pack	Case Weight	Case Size	20' FCL	40' FCL	40' HQ
0	8	7.9 kg (17.4 lbs.)	68 x 35 x 30 cm (26-3/4 x 13-3/4 x 11-3/4 in.)	3,024	6,336	7,392



320034 2PC Interlockable Organizer

- 37.5 W x 29.4 D x 6.6 H cm (14-3/4 x 11-1/2 x 2-1/2 in.) each
- Removable dividers
- Organizers lock together
- Carry up to three organizers at once
- Slide lock



Inner Pack	Case Pack	Case Weight	Case Size	20' FCL	40' FCL	40' HQ
0	3	5.5 kg (12 lbs.)	42 x 41 x 33 cm (16-1/2 x 16-1/8 x 13 in.)	1,470	3,045	3,480



Tools & accessories not included



Accessories not included

320027 3PC Interlockable Organizer

- 30.8 W x 22 D x 6.6 H cm (12-1/8 x 8-5/8 x 2-1/2 in.) each
- Various hardware solution
- Removable dividers; side latches
- Carry up to 3 at once
- Organized stacking
- 3pc Items



Case Pack	Case Weight	Case Size	20' FCL	40' FCL	40' HQ
6	9.6 kg (21.2 lbs.)	65 x 25 x 59 cm (25-1/2 x 9-7/8 x 23-1/4 in.)	1,836	3,672	4,212



Tools & accessories not included



Accessories not included





320041 38 cm (15 in.) Quad-side Organizer

- 38 W x 30 D x 14.1 H cm (15 x 12 x 5-1/2 in.)
- Individual latches, to four separate storage areas
- Removable dividers to customize compartments



Case Pack	Case Weight	Case Size	20' FCL	40' FCL	40' HQ
4	7.5 kg (16.5 lbs.)	60 x 42 x 32 cm (23-5/8 x 16-1/2 x 12-5/8 in.)	1,428	3,024	3,456



320042 Mini Double Side Organizer

- 22.4 W x 16.4 D x 6 H cm (8-3/4 x 6-1/2 x 2-1/2 in.)
- Removable dividers to customize compartments
- Double side



Accessories not included



Case Pack	Case Weight	Case Size	20' FCL	40' FCL	40' HQ
16	6.1 kg (13.5 lbs.)	52 x 36 x 24 cm (20-1/2 x 14-1/8 x 9-1/2 in.)	10,224	21,312	26,048

320043 43.2 cm (17 in.) Slide Bottom Organizer

- 43.2 W x 35.5 D x 12 H cm (17 x 14 x 4-3/4 in.)
- Slide-out bins with dividers
- Removable dividers to customize compartments



Case Pack	Case Weight	Case Size	20' FCL	40' FCL
6	10.9 kg (24 lbs.)	45 x 36 x 76 cm (17-3/4 x 14-1/8 x 30 in.)	1,458	2,998

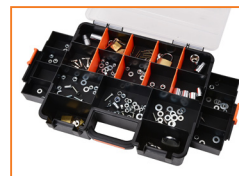

Accessories not included

Accessories not included

320080 Mini Interlock Case

- 26 W x 16.8 D x 6 H cm (10-1/4 x 6-5/8 x 2-3/8 in.)
- Various hardware solution
- Can be stacked one by one
- Removable dividers
- Plastic handle



Case Pack	Case Weight	Case Size	20' FCL	40' FCL	40' HQ
36	16 kg (35 lbs.)	59.5 x 41 x 47.5 cm (23-1/2 x 16 x 18-3/4 in.)	9,180	19,440	22,212



Accessories not included



Interlock multiple units

320081 3PC Mini Interlock Case

- 26 W x 16.8 D x 6 H cm (10-1/4 x 6-5/8 x 2-3/8 in.)
- Various hardware solution
- Can be stacked one by one
- Removable dividers
- Plastic handle
- 3pc Items



Case Pack	Case Weight	Case Size	20' FCL	40' FCL	40' HQ
12	16 kg (35 lbs.)	59.5 x 41 x 47.5 cm (23-1/2 x 16 x 18-3/4 in.)	3,060	6,480	7,404



Accessories not included



Interlock multiple units

320142 46 cm (18 in.) Short Plastic Tool Box

- 46 W x 16.5 D x 9.1 H cm (18 x 6-1/2 x 3-1/2 in.)
- 7 Compartments
- Removable dividers
- Ideal for small part storage
- Plastic handle and latches



Accessories not included



Case Pack	Case Weight	Case Size	20' FCL	40' FCL
6	3.8 kg (8.3 lbs.)	46.5 x 33.5 x 28 cm (18-1/4 x 13 x 11 in.)	4,248	8,748

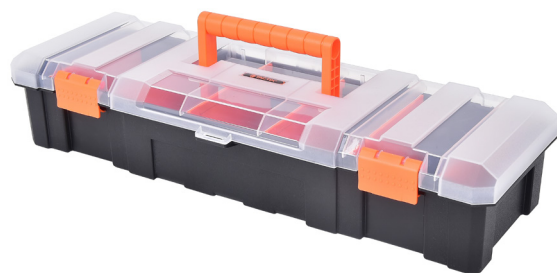

320144 46 cm (18 in.) Tall Plastic Tool Box

- 46 W x 16.5 D x 12.2 H cm (18 x 6-1/2 x 4-3/4 in.)
- 7 Compartments
- Removable dividers
- Ideal for small part storage
- Plastic handle and latches



Tools & accessories not included



Case Pack	Case Weight	Case Size	20' FCL	40' FCL
6	5.1 kg (11 lbs.)	47.5 x 34.8 x 38 cm (18-3/4 x 13-3/4 x 15 in.)	2,832	5,922

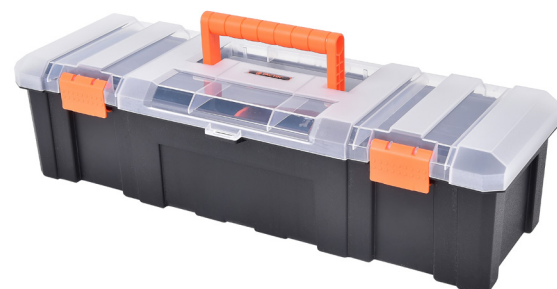



320048 39 cm (15-3/8 in.) Double Sided Tool Box

- 39 W x 32.5 D x 16.3 H cm (15-3/8 x 12-3/4 x 6-1/2 in.)
- Removable tubs and dividers on each side to customize compartments
- Heavy-duty aluminum latches
- Unique lid design keeps contents in allocated tubs



Case Pack	Case Weight	Case Size	20' FCL	40' FCL	40' HQ
4	9.9 kg (21.8 lbs.)	68 x 42 x 35 cm (26-3/4 x 16-1/2 x 13-3/4 in.)	1,056	2,184	2,548

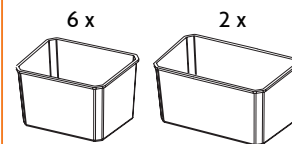
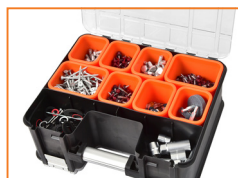

Accessories not included



320044 16.5 cm (6-1/2 in.) 6 Tub Heavy Duty Organizer

- 31 W x 16.5 D x 8.5 H cm (12-1/4 x 6-1/2 x 3-3/8 in.)
- Removable tubs for small parts storage
- Heavy-duty aluminum latches
- Unique lid design keeps contents in allocated tubs



Case Pack	Case Weight	Case Size	20' FCL	40' FCL	40' HQ
12	7.9 kg (17.4 lbs.)	52 x 37 x 35 cm (20-1/2 x 14-1/2 x 13-3/4 in.)	4,968	10,296	12,012

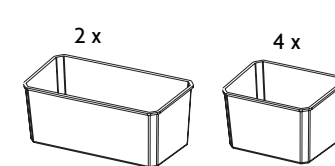

Accessories not included



320060 9 Tub Heavy Duty Organizer

- 43.2 W x 36 D x 11 H cm (17 x 14-1/8 x 4-1/4 in.)
- Removable tubs to customize compartments
- Heavy-duty aluminum latches
- Unique lid design keeps contents in allocated tubs



Case Pack	Case Weight	Case Size	20' FCL	40' FCL	40' HQ
8	20.2 kg (44.5 lbs.)	45 x 40 x 93 cm (17-3/4 x 15-3/4 x 36-5/8 in.)	1,280	2,560	3,072

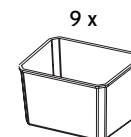

Accessories not included

Accessories not included



320062 6 Tub Heavy Duty Organizer

- 33.2 W x 33.2 D x 11.1 H cm (13 x 13 x 4-1/8 in.)
- Removable tubs to customize compartments
- Heavy-duty aluminum latches
- Unique lid design keeps contents in allocated tubs



Case Pack	Case Weight	Case Size	20' FCL	40' FCL	40' HQ
6	11.2 kg (26.7 lbs.)	36 x 35 x 71 cm (14-1/8 x 13-3/4 x 28 in.)	1,728	3,672	4,158

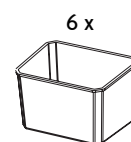
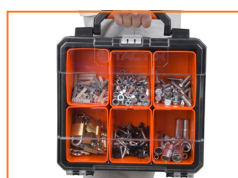

Accessories not included

Accessories not included

ORGANIZER

320067 9-Tub Heavy Duty Organizer

- 45.5 W x 37.5 D x 8 H cm (18 x 14-3/4 x 3-1/8 in.)
- Durable polycarbonate lid to identify contents
- Heavy duty aluminum latches
- Removable tubs
- Integrated weather-proof seal
- Built-in shock-absorbing feet



IP53

Case Pack	Case Weight	Case Size	20' FCL	40' FCL	40' HQ
8	18 kg (39.7 lbs.)	47 x 40 x 61 cm (18-1/2 x 15-3/4 x 24 in.)	1,800	3,760	4,640



Accessories not included



320068 8-Tub Heavy Duty Organizer

- 22.7 W x 37.5 D x 8 H cm (9 x 14-3/4 x 3-1/8 in.)
- Durable polycarbonate lid to identify contents
- Heavy duty aluminum latches
- Removable tubs
- Integrated weather-proof seal
- Built-in shock-absorbing feet



IP53

Case Pack	Case Weight	Case Size	20' FCL	40' FCL	40' HQ
16	20.5 kg (45.2 lbs.)	47 x 40 x 61 cm (18-1/2 x 15-3/4 x 24 in.)	3,600	7,520	9,280



Accessories not included



320040 3 PC Organizer Set

- Frame size: 33.4 W x 28 D x 24 H cm (13-1/8 x 11 x 9-1/2 in.)
- Organizer size: 31 W x 27 D x 6 H cm (12-1/8 x 10-5/8 x 2-1/4 in.)
- Removable dividers to customize compartments



Inner Pack	Case Pack	Case Weight	Case Size	20' FCL	40' FCL
0	4	14 kg (29 lbs.)	60 x 35.5 x 51 cm (23-1/2 x 14 x 20 in.)	1,056	2,208



Accessories not included



320047 Clear Organizer Rack Set

- 39.4 W x 40.4 D x 30.7 H cm (15-1/2 x 16 x 12 in.)
- 2 x Middle clear organizers on the first shelf - 20 compartments with removable dividers - size: 35W x 27D x 5H cm - 320032
- 1 x Big clear organizer on the second shelf - 8 compartments - size: 35W x 27D x 9.5H cm - 320030
- 8 x Small clear organizers on the last drawer - size: 13.7W x 9D x 9.8H cm
- Black frame with orange handle and locking system



Case Pack	Case Weight	Case Size	20' FCL	40' FCL	40' HQ
2	13 kg (29 lbs.)	43 x 43 x 65 cm (17 x 17 x 25-1/2 in.)	450	914	1,100



8 x

Accessories not included





321160 43.2 cm (17 in.) Metal Organizer Case

- 43.2 W x 33 D x 9.5 H cm (17 x 13 x 3-3/4 in.)
- Durable formed steel construction
- 20 x Removable plastic tubs with lids
- Heavy duty aluminum latches
- Tough powder coated finish
- Comfort grip handle
- Safety latch



Tools & assortments not included



Case Pack	Case Weight	Case Size	20' FCL	40' FCL	40' HQ
4	19 kg (42 lbs.)	48.5 x 44 x 37 cm (19 x 17-1/4 x 14-1/2 in.)	1,512	3,216	3,752



321162 32.8 cm (13 in.) Metal Organizer Case

- 32.8 W x 22.5 D x 5.2 H cm (13 x 8-7/8 x 2 in.)
- Durable formed steel construction
- 7 x Removable plastic tubs with lids
- Heavy duty aluminum latches
- Tough powder coated finish
- Comfort grip handle
- Safety latch



Tools & assortments not included



Case Pack	Case Weight	Case Size	20' FCL	40' FCL	40' HQ
4	10.5 kg (23 lbs.)	37.5 x 28 x 27 cm (16-3/4 x 11 x 10-1/2 in.)	4,416	9,088	10,224



321164 32.8 cm (13 in.) Double-sided Metal Organizer Case

- 32.8 W x 22.5 D x 10.5 H cm (13 x 8-7/8 x 4-1/8 in.)
- Durable formed steel construction
- 15 x Removable plastic tubs with lids
- Heavy duty aluminum latches
- Tough powder coated finish
- Comfort grip handle
- Safety latch



Case Pack	Case Weight	Case Size	20' FCL	40' FCL	40' HQ
4	16 kg (35 lbs.)	37.5 x 47 x 27 cm (16-3/4 x 18-1/2 x 10-1/2 in.)	2,496	5,120	5,760



Tools & assortments not included



Tools & assortments not included

ORGANIZER

320050 Van Utility Storage-A

- 48 W x 34 D x 86.5 H cm (19 x 13-3/8 x 34 in.)
- Fully welded steel construction
- Ball bearing drawer slides
- Locking side panel
- Ball bearing slides
- 4 x Tie-down points
- 6 x Storage bins
- 7 x organizers
- 1 x Lockable drawer
- Aluminum slide handles



Case Pack	Case Weight	Case Size	20' FCL	40' FCL
1	44 kg (96.8 lbs.)	58 x 47 x 90 cm (22-4/5 x 18-1/2 x 35-1/2 in.)	72	176



8 x Slide-out trays



4 x Tie-down points



Aluminum slide handles



Locking side panel



6 x Storage bins

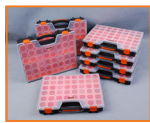

7 x Organizers



320052 Van Utility Storage-B

- 50.5 W x 40 D x 55.2 H cm (19-7/8 x 15-3/4 x 21-3/4 in.)
- Fully welded steel construction
- Ball bearing drawer slides
- Locking side panel
- Ball bearing slides
- 2 x Tie-down points
- 1 x Lockable drawer
- 2 x 410mm Thin organizers
- 2 x 410mm Thick organizers
- Aluminum slide handles



Case Pack	Case Weight	Case Size	20' FCL	40' FCL
1	29 kg (63.8 lbs.)	57 x 46 x 62 cm (22-1/2 x 18-1/9 x 24-1/2 in.)	189	396



Locking side panel

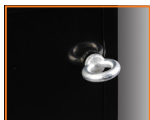

2 x Tie-down points



Aluminum slide handles

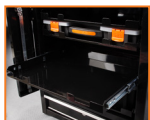

Ball bearing slides



Lockable drawer



4 x 410mm organizers



320054 Van Utility Storage-C

- 50.5 W x 40 D x 60.3 H cm (19-7/8 x 15-3/4 x 23-3/4 in.)
- Fully welded steel construction
- Ball bearing drawer slides
- Locking front panel
- 2 x Tie-down points
- 1 x Lockable drawer
- 5 x Double-sided organizers
- Aluminum slide handles



Case Pack	Case Weight	Case Size	20' FCL	40' FCL
1	23.5 kg (51.7 lbs.)	57 x 46 x 68 cm (22-1/2 x 18-1/9 x 26-3/4 in.)	166	346



Locking front panel

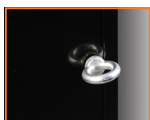

2 x Tie-down points



Aluminum slide handles

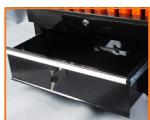

Lockable drawer



5 x Double-sided organizer



320 x 260 x 80mm



MODULAR TUBS ORGANIZER SYSTEM



(Accessories not included)



- A** 320150 29.5 cm (11-1/2 in.) Modular Tubs Organizer - Thin
- B** 320152 40.4 cm (16 in.) Modular Tubs Organizer - Thin
- C** 320160 29.5 cm (11-1/2 in.) Modular Tubs Organizer - Thick
- D** 320162 40.4 cm (16 in.) Modular Tubs Organizer - Thick
- E** 320180 Modular Storage Rack With 2x Organizers
- F** 320056 Van Utility Storage

**COMPLETE
HARDWARE
STORAGE
SOLUTION**

ORGANIZER

320150 29.5 cm (11-1/2 in.) Modular Tubs Organizer - Thin

- 29.5 W x 31.5 D x 5.7 H cm (11-1/2 x 12-3/8 x 2-1/4 in.)
- Removable tubs and dividers to customize compartments
- Cam-action ABS latches

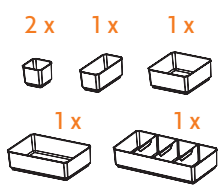
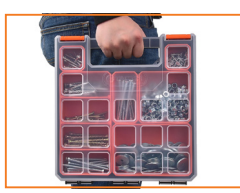

6
STANDARD
TUBS



Accessories not included

Case Pack	Case Weight	Case Size	20' FCL	40' FCL	40' HQ
12	9.2 kg (20 lbs.)	62 x 34 x 35 cm (24-3/8 x 13-3/8 x 13-3/4 in.)	4,464	9,360	10,920



320152 40.4 cm (16 in.) Modular Tubs Organizer - Thin

- 40.4 W x 31.5 D x 5.7 H cm (16 x 12-1/2 x 2-1/4 in.)
- Removable tubs and dividers to customize compartments
- Cam-action ABS latches

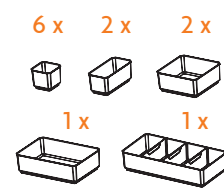
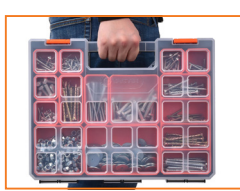

12
STANDARD
TUBS



Accessories not included

Case Pack	Case Weight	Case Size	20' FCL	40' FCL	40' HQ
12	13 kg (29 lbs.)	66 x 43 x 35 cm (26 x 16-7/8 x 13-3/4 in.)	3,096	6,552	7,644



320160 29.5 cm (11-1/2 in.) Modular Tubs Organizer - Thick

- 29.5 W x 31.5 D x 9.7 H cm (11-1/2 x 12-1/2 x 3-7/8 in.)
- Removable tubs and dividers to customize compartments
- Cam-action ABS latches

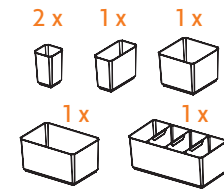

6
DEEP
TUBS



Accessories not included

Case Pack	Case Weight	Case Size	20' FCL	40' FCL	40' HQ
8	8.3 kg (18 lbs.)	62 x 34 x 41 cm (24-3/8 x 13-3/8 x 16-1/8 in.)	2,480	5,200	6,240



320162 40.4 cm (16 in.) Modular Tubs Organizer - Thick

- 40.4 W x 31.5 D x 9.7 H cm (16 x 12-1/2 x 3-7/8 in.)
- Removable tubs and dividers to customize compartments
- Cam-action ABS latches

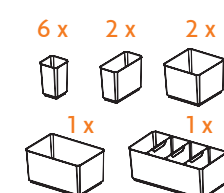

12
DEEP
TUBS



Accessories not included

Case Pack	Case Weight	Case Size	20' FCL	40' FCL	40' HQ
8	11.4 kg (25 lbs.)	66 x 43 x 41 cm (26 x 16-7/8 x 16-1/8 in.)	1,720	3,640	4,368





(Contents not included)

320180 Modular Storage Rack With 2x Organizers

- 33.1 W x 32.1 D x 18.4 H cm (13 x 12-5/8 x 7-1/4 in.)
- Includes 2 x organizers (320150)
- 9 Compartments per organizer

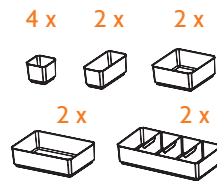

Case Pack	Case Weight	Case Size	20' FCL	40' FCL	40' HQ
4	12.2 kg (27 lbs.)	69 x 38 x 42 cm (27-1/8 x 15 x 16-1/2 in.)	960	2,040	2,448

320056 Van Utility Storage

- 47.8 W x 38 D x 80.6 H cm (18-3/4 x 15 x 31-3/4 in.)
- Slide-out tray
- Lock in organizers & drawers
- 4 x Vehicle tie-down points
- Aluminum side handles
- 6 x Storage bins
- 8 x Organizers(320152) - 15 compartments per organizer



Case Pack	Case Weight	Case Size	20' FCL	40' FCL	40' HQ
1	35.9 kg (79 lbs.)	49.5 x 40 x 82.8 cm (19-1/2 x 15-3/4 x 32-5/8 in.)	110	240	360



Slide-out tray



Lock in organizers & drawers



6 x Storage bins

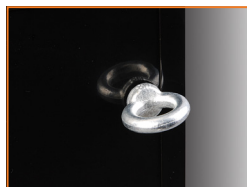

4 x Vehicle tie-down points



Aluminum side handles



8 x Organizers(320152) - 15 compartments per organizer

ORGANIZER

Ideal for Fasteners, Fishing Tackles, Accessories & Any Small Parts!

WEATHER & DUST RESISTANT IP65 RATED

Transparent finish for easy viewing without opening

Included 320076 x 2, 320077, 320078

Easy open latches provide strong security

Customize the storage with removable dividers



320076 Weather Proof Organizer - S

- 17.7 W x 10.5 D x 5.1 H cm (7 x 4-1/8 x 2 in.)
- 1 - 6 Adjustable compartments



IP65



NEW

Case Pack	Case Weight	Case Size	20' FCL	40' FCL	40' HQ
16	3.64 kg (8 lbs.)	36 x 25 x 23 cm (14-1/2 x 9-7/8 x 9 in.)	23,840	48,960	53,856



320077 Weather Proof Organizer - M

- 17.7 W x 22 D x 5.1 H cm (7 x 8-5/8 x 2 in.)
- 1 - 12 Adjustable compartments



IP65



NEW

Case Pack	Case Weight	Case Size	20' FCL	40' FCL	40' HQ
16	6.78 kg (15 lbs.)	38 x 47 x 23 cm (15 x 18-1/2 x 9 in.)	11,520	24,000	26,400



320078 Weather Proof Organizer - L

- 35.8 W x 22 D x 5.1 H cm (14 x 8-5/8 x 2 in.)
- 1 - 24 Adjustable compartments



IP65



NEW

Case Pack	Case Weight	Case Size	20' FCL	40' FCL	40' HQ
16	11.4 kg (25 lbs.)	39 x 47 x 44 cm (15-1/4 x 18-1/2 x 17-1/4 in.)	5,760	11,600	13,920



320079 4 in 1 Weather Proof Organizer Set

- 1 Large + 1 medium + 2 small organizers
- 4 - 48 Adjustable compartments



IP65



NEW

Case Pack	Case Weight	Case Size	20' FCL	40' FCL	40' HQ
12	17.1 kg (37.6 lbs.)	39 x 48 x 64.2 cm (15-1/4 x 18-3/4 x 25-1/4 in.)	2,592	5,220	6,960





ORGANIZER SYSTEM



ORGANIZER



320650 16.5 cm (6-1/2 in.) Storage Box

- 18 W x 16.6 D x 5.2 H cm (7 x 6-1/2 x 2 in.)
- Removable dividers
- 6 Compartments



Case Pack	Case Weight	Case Size	20' FCL	40' FCL
16	3.2 kg (7 lbs.)	44 x 40 x 19 cm (17-3/8 x 15-3/4 x 7-1/2 in.)	13,440	28,800



320651 18.4 cm (7-1/2 in.) Storage Box

- 18 W x 16.6 D x 10.2 H cm (7 x 6-1/2 x 4 in.)
- 1 x Removable tray with dividers inside
- 4 Compartments

NEW



Case Pack	Case Weight	Case Size	20' FCL	40' FCL	40' HQ
8	3 kg (6.6 lbs.)	44 x 40 x 19 cm (17-1/4 x 15-3/4 x 7-3/8 in.)	6,720	14,400	15,600



320652 32.3 cm (12-3/4 in.) Storage Box

- 32.3 W x 18 D x 5.2 H cm (12-3/4 x 7 x 2 in.)
- Removable dividers
- 13 Compartments



Case Pack	Case Weight	Case Size	20' FCL	40' FCL
8	3.2 kg (7 lbs.)	40 x 24 x 35 cm (15-3/4 x 9-1/2 x 13-3/4 in.)	6,720	13,920



320655 4 in 1 Storage Box Set

- Organizer 1(320650): 18 W x 16.6 D x 5.2 H cm (7 x 6-1/2 x 2 in.) x2
- Organizer 2(320651): 18 W x 16.6 D x 10.2 H cm (7 x 6-1/2 x 4 in.) x1
- Organizer 3(320652): 32.3 W x 18 D x 5.2 H cm (12-3/4 x 7 x 2 in.) x1
- Removable tray and dividers inside
- 32 Compartments

NEW



Case Pack	Case Weight	Case Size	20' FCL	40' FCL	40' HQ
30	29.2 kg (64 lbs.)	68 x 57 x 81 cm (26-3/4 x 22-3/8 x 31-3/4 in.)	1,980	4,140	6,210



320654 6 PC Storage Bin Set

- 11.1 W x 16.9 D x 8.3 H cm (4-3/8 x 6-5/8 x 3-1/4 in.) each
- Bins can be stacked, nested and side locked



6 x



Case Pack	Case Weight	Case Size	20' FCL	40' FCL	40' HQ
8	4.9 kg (10.8 lbs.)	47 x 37 x 35 cm (18-1/2 x 14-1/2 x 13-3/4 in.)	3,600	7,536	8,792



Can fit into 320656



Can fit into 320658

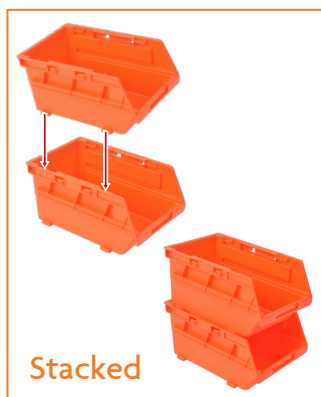

Stacked



Nested



Locked



Side locked

ORGANIZER



320660 16.5 cm (6-1/2 in.) Waterproof Storage Box

- 18 W x 16.5 D x 5.2 H cm (7 x 6-1/2 x 2 in.)
- Removable dividers
- 6 Compartments
- Cam-action latch
- Water tight and dust proof seal



IP68



6 942629 207832



Case Pack	Case Weight	Case Size	20' FCL	40' FCL
16	6.3 kg (14 lbs.)	45 x 40 x 19 cm (17-3/4 x 15-3/4 x 7-1/2 in.)	13,440	28,800



Both organizers fit into 320670 & 320672

Accessories not included

320662 32.3 cm (12-3/4 in.) Waterproof Storage Box

- 32.3 W x 18 D x 5.2 H cm (12-3/4 x 7 x 2 in.)
- Removable dividers
- 9 Compartments
- Cam-action latch
- Water tight and dust proof seal



IP68



6 942629 207849



Case Pack	Case Weight	Case Size	20' FCL	40' FCL
8	5.7 kg (12.6 lbs.)	40 x 25 x 35 cm (15-3/4 x 10 x 13-3/4 in.)	6,384	13,248



Fit into 320672

Accessories not included



320656 52.3 cm (20-1/2 in.) Plastic Tote Tray

- 52.3 W x 36.9 D x 17 H cm (20-1/2 x 14-1/2 x 6-5/8 in.)
- Extra deep tray
- Perforations for tools



Case Pack	Case Weight	Case Size	20' FCL	40' FCL	40' HQ
12	13.2 kg (29.1 lbs.)	54 x 39 x 60 cm (21-1/4 x 15-3/8 x 23-5/8 in.)	2,196	4,500	6,000



Can be nested



Can match 4x 320654 & 2x 320652 or 320662

ORGANIZER



320658 58 cm (22-3/4 in.) Cantilever Tool Box

- 58 W x 35.4 D x 28.6 H cm (22-3/4 x 13-7/8 x 11-1/4 in.)
- Professional grade construction
- Full length aluminum handle
- Cantilever function allows for full access to bottom box
- Steel latches for durability
- Removable dividers to customize compartments at top



Case Pack	Case Weight	Case Size	20' FCL	40' FCL	40' HQ
4	18.7 kg (41 lbs.)	61 x 73 x 61 cm (24 x 28-3/4 x 24 in.)	324	684	912



Can match 4x 320654 & 2x 320650 or 320660



4PC

ORGANIZERS



(Accessories not included)

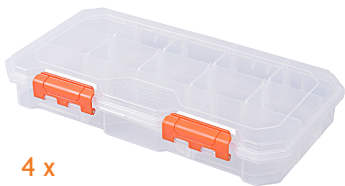

4 x

320670 Modular Storage Tower - 4 Organizers

- 37.8 W x 18 D x 32 H cm (14-7/8 x 7 x 12-1/2 in.)
- Modular system - Expands with your storage needs
- Interlock multiple units - Vertically or horizontally
- Wall-mountable
- 4 Organizers - Each with 13 customizable compartments



Case Pack	Case Weight	Case Size	20' FCL	40' FCL	40' HQ
4	11.1 kg (24.5 lbs.)	40 x 40 x 68 cm (15-3/4 x 15-3/4 x 26-3/4 in.)	960	2,000	2,400



ORGANIZER



320672 Modular Storage Tower – 6 Organizers

- 37.8 W x 18 D x 32 H cm (14-7/8 x 7 x 12-1/2 in.)
- Modular system - Expands with your storage needs
- Interlock multiple units - Vertically or horizontally
- Wall-mountable
- 6 Organizers - With 6 or 13 customizable compartments



Case Pack	Case Weight	Case Size	20' FCL	40' FCL	40' HQ
4	11.2 kg (24.7 lbs.)	40 x 40 x 68 cm (15-3/4 x 15-3/4 x 26-3/4 in.)	960	2,000	2,400





(Accessories not included)

9PC ORGANIZERS



9 x Accessories not included

320674 Modular Storage Tower – 9 Bins

- 37.8 W x 15.2 D x 32 H cm (14-7/8 x 6 x 12-1/2 in.)
- Modular system - Expands with your storage needs
- Interlock multiple units - Vertically or horizontally
- Wall-mountable
- 9 Organizers - With 2 customizable compartments



Case Pack	Case Weight	Case Size	20' FCL	40' FCL	40' HQ
4	9.4 kg (20.7 lbs.)	39 x 33 x 68 cm (15-3/8 x 13 x 26-3/4 in.)	1,372	2,800	3,200



ORGANIZER



(Accessories not included)

9PC
BINS

320676 Modular Storage Tower – 9 Bins

- 37.8 W x 17.1 D x 32 H cm (14-7/8 x 6-5/8 x 12-1/2 in.)
- Modular system - Expands with your storage needs
- Interlock multiple units - Vertically or horizontally
- Wall-mountable
- 9 Bins - Can be stacked, nested and side locked



Case Pack	Case Weight	Case Size	20' FCL	40' FCL
4	8.3 kg (18.3 lbs.)	40 x 38 x 68 cm (15-3/4 x 15 x 26-3/4 in.)	1,152	2,400





320603 10 PC Storage Bin Set

- 8.5 W x 13 D x 5.3 H cm (3-1/4 x 5-1/8 x 2 in.)
- 4 Hangers allow bins to attach to most wall surfaces
- Bins can stack



Case Pack	Case Weight	Case Size	20' FCL	40' FCL	40' HQ
10	5 kg (11 lbs.)	50 x 32 x 34 cm (19-3/4 x 12-1/2 x 13-1/2 in.)	5,750	11,840	13,310



320604 8 PC Storage Bin Set

- 10.5 W x 16.4 D x 7.6 H cm (4-1/8 x 6-1/2 x 3 in.)
- 4 Hangers allow bins to attach to most wall surfaces
- Bins can stack



Case Pack	Case Weight	Case Size	20' FCL	40' FCL	40' HQ
6	5 kg (11 lbs.)	36 x 36 x 38 cm (14-1/8 x 14-1/8 x 15 in.)	3,456	7,128	8,316



320606 4 PC Storage Bin Set

- 15 W x 24 D x 12.8 H cm (5-7/8 x 9-1/2 x 5 in.)
- 3 Hangers allow bins to attach to most wall surfaces
- Bins can stack



Case Pack	Case Weight	Case Size	20' FCL	40' FCL	40' HQ
4	3.9 kg (8.6 lbs.)	53 x 32 x 35 cm (20-7/8 x 12-5/8 x 13-3/4 in.)	1,848	3,792	4,424



320610 6 PC Storage Bin Set

- 10.5 W x 13.5 D x 8.2 H cm (4-1/8 x 5-1/4 x 3-1/8 in.)
- 2 Hangers allow bins to attach to most wall surfaces
- Bins can stack



Case Pack	Case Weight	Case Size	20' FCL	40' FCL	40' HQ
6	3.5 kg (8 lbs.)	35 x 33 x 34 cm (13-3/4 x 13 x 13-3/8 in.)	4,104	8,568	9,996

PLASTIC STORAGE BIN

320608 1 PC Storage Bin

- 20.5 W x 33 D x 15.6 H cm (8 x 13 x 6-1/8 in.)



Case Pack	Case Weight	Case Size	20' FCL	40' FCL	40' HQ
48	19.9 kg (44 lbs.)	69 x 43 x 105 cm (27-1/8 x 16-7/8 x 41-3/8 in.)	4,128	8,544	9,792



320616 1 PC Storage Bin

- 28 W x 42.5 D x 18.4 H cm (11 x 16-3/4 x 7-1/4 in.)



Inner Pack	Case Pack	Case Weight	Case Size	20' FCL	40' FCL
0	12	12.1 kg (26.7 lbs.)	60 x 45 x 68 cm (23-5/8 x 17-3/4 x 26-3/4 in.)	1,728	3,600



320618 1 PC Storage Bin

- 28 W x 42.5 D x 26 H cm (11 x 16-3/4 x 10-1/4 in.)



Inner Pack	Case Pack	Case Weight	Case Size	20' FCL	40' FCL
0	8	9.5 kg (21 lbs.)	60 x 45 x 68 cm (23-5/8 x 17-3/4 x 26-3/4 in.)	1,152	2,400



320612 3 PC Rail Kit Set

- 32.3 W x 7.6 D x 0.7 H cm (12-3/4 x 3 x 3/8 in.)
- Interlocking construction for easy mounting
- Fits Tactix™ storage bins



Tool & accessories not included



Inner Pack	Case Pack	Case Weight	Case Size	20' FCL	40' FCL	40' HQ
4	48	9 kg (20 lbs.)	36 x 36 x 32 cm (14-1/8 x 14-1/8 x 12-5/8 in.)	32,256	66,528	76,032



320601 15 PC Plastic Bin Set

- 5 x Bin 1: 10.2 W x 10 D x 6 H cm (4 x 4 x 2-3/8 in.)
- 5 x Bin 2: 10.2 W x 16 D x 7.5 H cm (4 x 6-1/4 x 3 in.)
- 5 x Bin 3: 10.2 W x 21.5 D x 7.5 H cm (4 x 8-1/2 x 3 in.)
- 6 x Wall-mountable rails included for mounting the bins



Case Pack	Case Weight	Case Size	20' FCL	40' FCL	40' HQ
6	9.3 kg (20.5 lbs.)	55 x 50 x 54 cm (21-5/8 x 19-5/8 x 21-1/4 in.)	1,056	2,304	2,640



ORANGE BIN



BLACK BIN



STORAGE BIN SET



320140 2 PC 31 cm (12 in.) Plastic Organizer

- 31 W x 11.3 D x 6.4 H cm (12 x 4-3/8 x 2-1/2 in.)
- 4 Compartments
- Ideal for small part storage



Accessories not included

6 942629 265481

Case Pack	Case Weight	Case Size	20' FCL	40' FCL
16	7 kg (15.5 lbs.)	47.5 x 34.8 x 38 cm (18-3/4 x 13-3/4 x 15 in.)	7,552	15,792

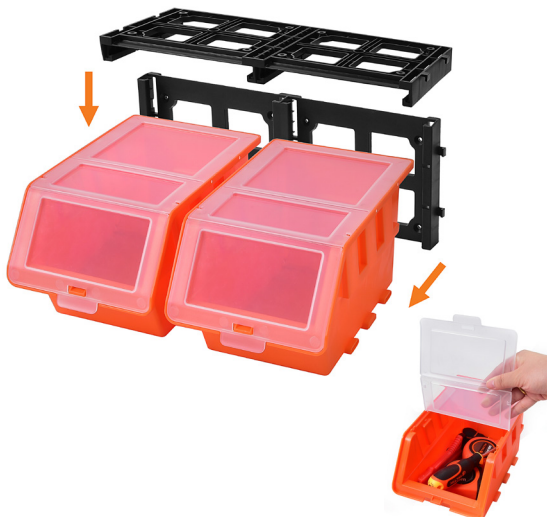

320622 4 Pack Storage Tote With Lids & Mounting Rails

- Tote size: 13.6 W x 22 D x 12 H cm (5-1/4 x 8-1/2 x 4-3/4 in.)
- Rail size: 30.2 W x 13.6 D x 1.7 H cm (11-7/8 x 5-1/4 x 1/2 in.)
- 4 x Storage totes with removable clear lids and 2 x versatile mounting rails
- Mounting hardware included: 8 x M4*30 tap screws & anchors
- Ideal for storing small parts and accessories

6 942629 264910

Case Pack	Case Weight	Case Size	20' FCL	40' FCL	40' HQ
6	8.3 kg (18.3 lbs.)	64 x 30 x 61 cm (25-1/4 x 11-3/4 x 24 in.)	1,350	2,844	3,336



Tool & accessories not included



Tool & accessories not included



Tool & accessories not included

320600 43 PC Organization System

- 2pc Plastic panels - 48.3 W x 1.47 D x 54 H cm (19 x 5/8 x 21-1/4 in.)
- 16pc Bin 1 - 10.2 W x 10 D x 6 H cm (4 x 3-7/8 x 2-3/8 in.)
- 8pc Bin 2 - 10.2 W x 16 D x 7.5 H cm (4 x 6-1/4 x 3 in.)
- 4pc Bin 3 - 10.2 W x 21.5 D x 7.5 H cm (4 x 8-1/2 x 3 in.)
- Affixes to most wall surfaces (hardware included)

Bin 1

Bin 2

Bin 3



16 x



8 x

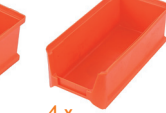

4 x

6 942629 239727



• 1 pc bit holder

• 10 pc versatile hooks

• 1 pc tool holder

• 1 pc tool hook

Inner Pack	Case Pack	Case Weight	Case Size	20' FCL	40' FCL
0	3	14 kg (31 lbs.)	51 x 46 x 59 cm (20 x 18-1/8 x 23-1/4 in.)	630	1,355



320619 15 PC Storage Bin Cabinet

- 57.6 W x 17.5 D x 46.8 H cm (22-5/8 x 6-7/8 x 18-3/8 in.)
- For garage, home or office use
- Removable bins lift out for easy access
- Heavy duty powder coated steel frame
- Easy to assemble metal rack frame
- Plastic side latches for easy to carry



Bin 320604



15 x



Case Pack	Case Weight	Case Size	20' FCL	40' FCL	40' HQ
1	5.5 kg (12 lbs.)	59 x 19 x 24 cm (23-1/4 x 7-1/2 x 9-1/2 in.)	1,044	2,160	2,640



320620 Bin Rack

- Removable bins lift out for easy access
- Comes with 47 bins
- Easy storage of parts, suppliers, fasteners, tools, hobby gear and more

Bin 1 320604 Bin 2 320606



32 x



15 x



Inner Pack	Case Pack	Case Weight	Case Size	20' FCL	40' FCL
0	1	20 kg (44 lbs.)	113 x 32 x 26 cm (44-1/2 x 12-1/2 x 10-1/4 in.)	324	666



320621 15 PC Table Top Bin Rack

- For garage, home or office use
- Removable bins lift out for easy access
- Heavy duty powder coated steel frame
- Easy to assemble metal rack frame



Tool & accessories not included



15 x



Case Pack	Case Weight	Case Size	20' FCL	40' FCL	40' HQ
6	37.6 kg (82.7 lbs.)	69 x 46 x 66 cm (27 x 18 x 26 in.)	822	1,728	2,064



320649 18 Tub Storage System

- For garage, home or office use
- Removable polypropylene bins
- Heavy duty powder coated steel frame
- Great for small parts storage & organization



Tool & accessories not included



18 x



Case Pack	Case Weight	Case Size	20' FCL	40' FCL	40' HQ
1	10.7 kg (23.5 lbs.)	69 x 24 x 34 cm (27 x 9-1/2 x 13-1/4 in.)	543	1,127	1,277





320680 11 Drawer Metal Frame Organizer

- 44.4 W x 17 D x 29.5 H cm (17-1/2 x 6-3/4 x 11-5/8 in.)
- Heavy duty construction
- Non-marking rubber feet
- 11 x Metal compartments
- EVA drawer liner inserts
- Recessed Handles
- Wall mountable
- Stackable unit



Tool & accessories not included



Case Pack	Case Weight	Case Size	20' FCL	40' FCL	40' HQ
4	25.4 kg (56 lbs.)	48 x 37 x 63 cm (18-7/8 x 14-1/2 x 24-3/4 in.)	864	1,800	2,400



8 x



2 x

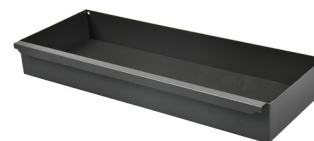

1 x



320681 18 Drawer Metal Frame Organizer

- Size: 38.2 W x 15.3 D x 31 H cm (15 x 6 x 12-1/4 in.)
- Heavy duty construction
- Non-marking rubber feet
- 18 x Plastic compartments
- Recessed Handles
- Wall mountable
- Stackable unit



Tool & accessories not included



Case Pack	Case Weight	Case Size	20' FCL	40' FCL	40' HQ
4	15.7 kg (35 lbs.)	41 x 35 x 66 cm (16-1/8 x 13-3/4 x 26 in.)	1,080	2,268	3,024



12 x



6 x

Tool & accessories not included

Tool & accessories not included



320682 9 Drawer Metal Frame Organizer

- Size: 38.2 W x 15.3 D x 31 H cm (15 x 6 x 12-1/4 in.)
- Heavy duty construction
- Non-marking rubber feet
- 9 x Plastic compartments
- Recessed Handles
- Wall mountable
- Stackable unit



Tool & accessories not included



Case Pack	Case Weight	Case Size	20' FCL	40' FCL	40' HQ
4	14.7 kg (32 lbs.)	41 x 35 x 66 cm (16-1/8 x 13-3/4 x 26 in.)	1,080	2,268	3,024



9 x

Tool & accessories not included

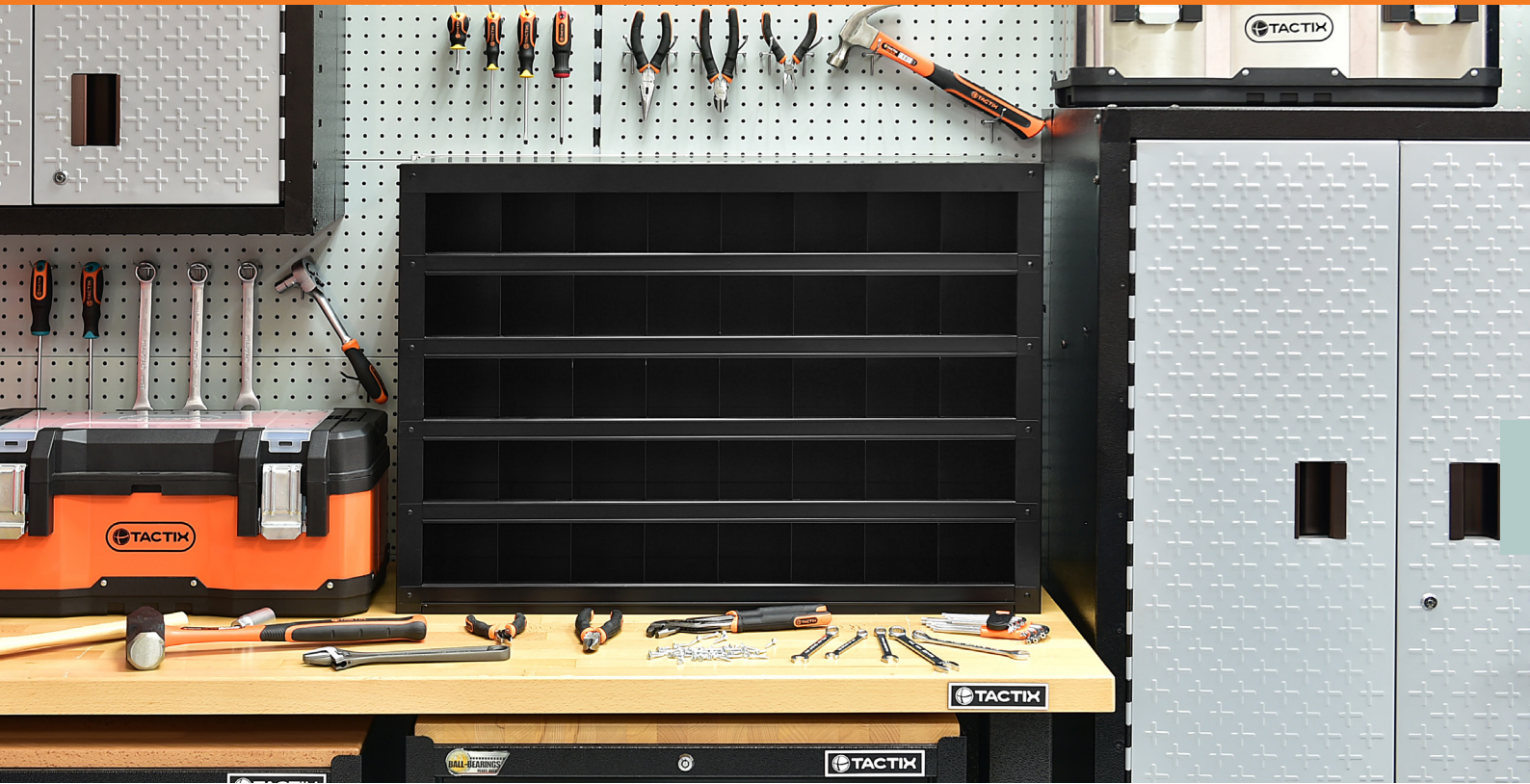

326902 Steel 40 Opening Bin

- 86 W x 30.3 D x 61.5 H cm (33-7/8 x 12 x 24-1/4 in.)
- All steel construction
- Wall mountable(Hardware not included)
- Powder-coated frame



Case Pack	Case Weight	Case Size	20' FCL	40' FCL	40' HQ
1	21.5 kg (47 lbs.)	88 x 63 x 32 cm (34-5/8 x 24-3/4 x 12-1/2 in.)	147	315	360



326903 Steel 72 Opening Bin

- 86 W x 30.3 D x 106.6 H cm (33-7/8 x 12 x 42 in.)
- All steel construction
- Wall mountable(Hardware not included)
- Powder-coated frame



Case Pack	Case Weight	Case Size	20' FCL	40' FCL	40' HQ
1	36.5 kg (80 lbs.)	88.5 x 109 x 32 cm (34-3/4 x 43 x 12-1/2 in.)	84	182	208





HARDWARE STORAGE CABINETS

- Ideal for small part storage
- Rear drawer stop tab prevents contents from spilling

Overall size:
26 x 27 x 16cm
(10-1/2 x 10-5/8 x 6-1/4 in.)



- Finger-grip drawer front

- Transparent drawers

- Drawer dividers included

Tools and assortments not included.

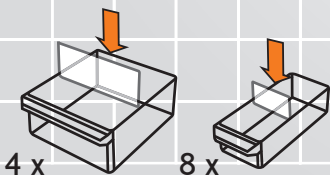

320630 12 Drawer Cabinet

Case Pack	Case Weight	Case Size	20' FCL	40' FCL	40' HQ
8	10.8 kg (23.8 lbs.)	27 x 16 x 26 cm (10-5/8 x 6-1/4 x 10-1/2 in.)	2,144	4,480	4,704



PLASTIC STORAGE BIN



320632 22 Drawer Cabinet

- 25 W x 50 D x 16 H cm (9-3/4 x 19-5/8 x 6-1/4 in.)
- Ideal for small part storage
- Transparent drawers
- Finger-grip drawer front
- Rear drawer stop tab prevents contents from spilling



Case Pack	Case Weight	Case Size	20' FCL	40' FCL	40' HQ
4	9.2 kg (20.3 lbs.)	50 x 16 x 25 cm (19-5/8 x 6-1/4 x 9-3/4 in.)	1,152	2,384	2,576

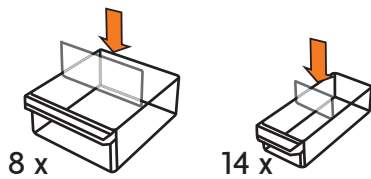

320634 18 Drawer Cabinet

- 47.5 W x 38.5 D x 16.2 H cm (18-5/8 x 15-1/8 x 6-3/8 in.)
- Ideal for small part storage
- Transparent drawers
- Finger-grip drawer front
- Rear drawer stop tab prevents contents from spilling



Case Pack	Case Weight	Case Size	20' FCL	40' FCL	40' HQ
4	11.1 kg (24.5 lbs.)	38.5 x 16.2 x 47.5 cm (15-1/8 x 6-3/8 x 18-5/8 in.)	768	1,600	2,000



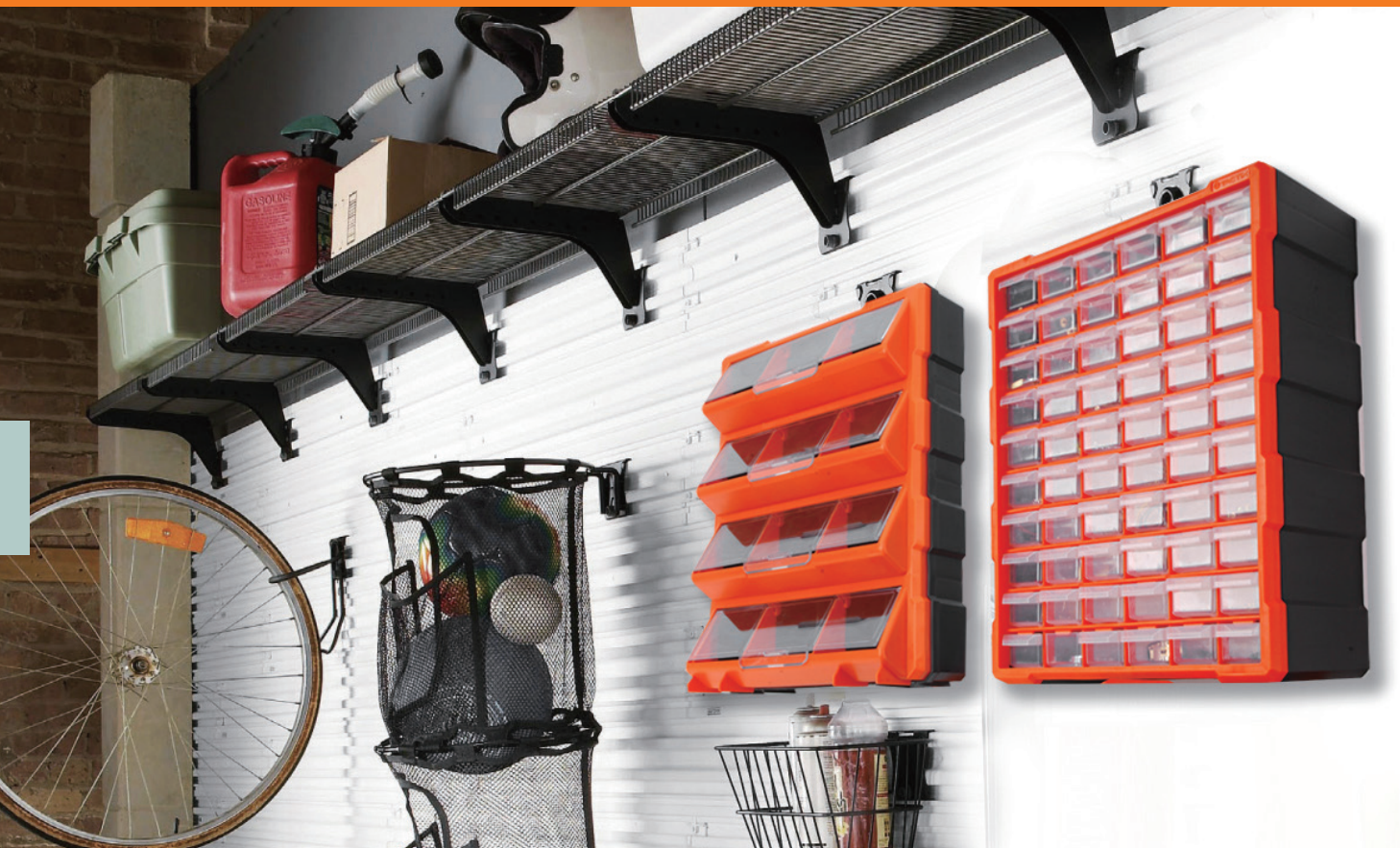

320638 60 Drawer Cabinet

- 47.5 W x 38.5 D x 16.2 H cm (18-5/8 x 15-1/8 x 6-3/8 in.)
- Ideal for small part storage
- Transparent drawers
- Finger-grip drawer front
- Rear drawer stop tab prevents contents from spilling



Case Pack	Case Weight	Case Size	20' FCL	40' FCL	40' HQ
4	13.5 kg (30 lbs.)	8.5 x 16.2 x 47.5 cm (15-1/8 x 6-3/8 x 18-5/8 in.)	768	1,600	2,000

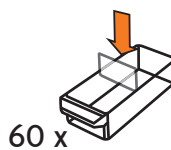

Tool & accessories not included



320648 12 Bin Flip Lid Cabinet

- 46 W x 36 D x 12 H cm (18-1/8 x 14-1/8 x 4-3/4 in.)
- Ideal for small part storage
- Transparent lids
- Wall mountable



Case Pack	Case Weight	Case Size	20' FCL	40' FCL	40' HQ
4	7.7 kg (17 lbs.)	36 x 12 x 46 cm (14-1/8 x 4-3/4 x 18-1/8 in.)	1,056	2,304	2,640

PLASTIC STORAGE BIN



320636 39 Drawer Cabinet

- 47.5 W x 38.5 D x 16.2 H cm (18-5/8 x 15-1/8 x 6-3/8 in.)
- Ideal for small part storage
- Transparent drawers
- Finger-grip drawer front
- Rear drawer stop tab prevents contents from spilling



Case Pack	Case Weight	Case Size	20' FCL	40' FCL	40' HQ
4	12.3 kg (27 lbs.)	38.5 x 16.2 x 47.5 cm (15-1/8 x 6-3/8 x 18-5/8 in.)	768	1,600	2,000

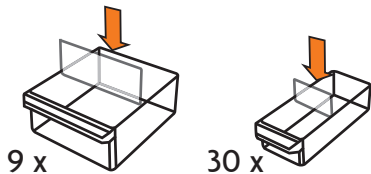

Tool & accessories not included



320644 39 Drawer Cabinet

- 47.5 W x 38.5 D x 16.2 H cm (18-5/8 x 15-1/8 x 6-3/8 in.)
- Ideal for small part storage
- Transparent drawers
- Finger-grip drawer front
- Rear drawer stop tab prevents contents from spilling



Case Pack	Case Weight	Case Size	20' FCL	40' FCL	40' HQ
4	12.7 kg (28 lbs.)	38.5 x 16.2 x 47.5 cm (15-1/8 x 6-3/8 x 18-5/8 in.)	768	1,600	2,000

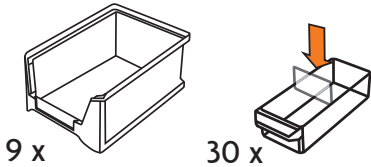

Tool & accessories not included



CLEAR STORAGE BOX

- Made from high quality, durable plastic
- Modular, stack multiple units to customize storage
- Integrated clip latches
- Ideal for storing items around the home, office and garage



HOME USE STORAGE

320260 3.5L Storage Box With Removable Tubs

- 38.8 W x 14.4 D x 11 H cm (15-1/4 x 5-5/8 x 4-3/8 in.)
- Made from high quality, durable plastic
- Modular, stack multiple units to customize storage
- 6 x Removable storage tubs



Case Pack	Case Weight	Case Size	20' FCL	40' FCL
15	9.3 kg (20.5 lbs.)	45 x 42 x 55 cm (17-3/4 x 16-1/2 x 21-5/8 in.)	3,900	8,400



Accessories not included



3.5L

320262 6L Storage Box With Lift-out Tray

- 30.5 W x 20.4 D x 15.5H cm (12 x 8 x 6 in.)
- Made from high quality, durable plastic
- Modular, stack multiple units to customize storage
- Soft-grip carry handle
- Lift-out tray insert to store & organize small parts



Case Pack	Case Weight	Case Size	20' FCL	40' FCL	40' HQ
30	17.9 kg (39.5 lbs.)	64 x 44 x 62 cm (25-1/4 x 17-1/2 x 24-1/2 in.)	4,050	8,370	11,160



Contents not included



6L

320264 15L Storage Box With Lift-out Tray

- 40.4 W x 30.4 D x 18.7 H cm (15-7/8 x 12 x 7-3/8 in.)
- Made from high quality, durable plastic
- Modular, stack multiple units to customize storage
- Soft-grip carry handle
- Lift-out tray insert to store & organize small parts



Case Pack	Case Weight	Case Size	20' FCL	40' FCL
24	28.6 kg (63 lbs.)	84 x 64 x 58 cm (33 x 25-1/4 x 22-7/8 in.)	2,304	4,800



Contents not included



15L

22L



320266 22L Storage Box With Lift-out Tray

- 40.4 W x 30.4 D x 25.7 H cm (15-7/8 x 12 x 10in.)
- Made from high quality, durable plastic
- Modular, stack multiple units to customize storage
- Soft-grip carry handle
- Lift-out tray insert to store & organize small parts



Case Pack	Case Weight	Case Size	20' FCL	40' FCL
20	27.4 kg (60.4 lbs.)	84 x 64 x 57 cm (33 x 25-1/4 x 22-1/2 in.)	1,920	4,000



Tools not included

35L



320280 35L Multi-purpose Storage Box

- 58 W x 37.5 D x 23.5 H cm (22-7/8 x 14-3/4 x 9-1/4 in.)
- Stack multiple units to customize storage
- Modular, stack multiple units to customize storage
- 4 x Wheels allow for easy mobility



Case Pack	Case Weight	Case Size	20' FCL	40' FCL	40' HQ
24	32.2 kg (71 lbs.)	77 x 60 x 60 cm (30-1/4 x 23-5/8 x 23-5/8 in.)	1,944	4,320	5,760



Tools not included

52L



320282 52L Multi-purpose Storage Box

- 58 W x 37.5 D x 34.5 H cm (22-7/8 x 14-3/4 x 13-1/2 in.)
- Made from high quality, durable plastic
- Stack multiple units to customize storage
- 4 x Wheels allow for easy mobility



Case Pack	Case Weight	Case Size	20' FCL	40' FCL	40' HQ
20	32 kg (70.5 lbs.)	77 x 60 x 65 cm (30-1/4 x 23-5/8 x 25-1/2 in.)	1,620	3,600	4,800



Tools not included

HOME USE STORAGE

320268 15L Household Medicine Box

- 40.4 W x 30.4 D x 18.7 H cm (15-7/8 x 12 x 7-3/8 in.)
- Made from high quality, durable plastic
- Soft-grip carry handle
- Lift-out carry tray
- Ideal container to hold first aid supplies or family medicine



Case Pack	Case Weight	Case Size	20' FCL	40' FCL
24	29 kg (64 lbs.)	84 x 64 x 58 cm (33 x 25-1/4 x 22-7/8 in.)	2,304	4,800



Contents not included

15L



320270 22L Household Medicine Box

- 40.4 W x 30.4 D x 25.7 H cm (15-7/8 x 12 x 10 in.)
- Made from high quality, durable plastic
- Soft-grip carry handle
- Lift-out carry tray
- Ideal container to hold first aid supplies or family medicine



Case Pack	Case Weight	Case Size	20' FCL	40' FCL
20	27.3 kg (60.2 lbs.)	84 x 64 x 57cm (33 x 25-1/4 x 22-1/2 in.)	1,920	4,000



Contents not included



Contents not included

22L



Mini



- Perfect for storing and transporting goods in the car, garage, home and office



2.8 cm
1-1/8 in.

3.6 cm
1-3/8 in.

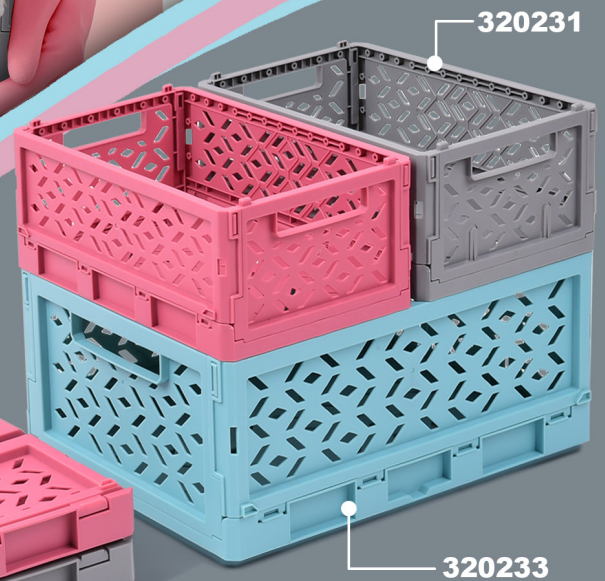
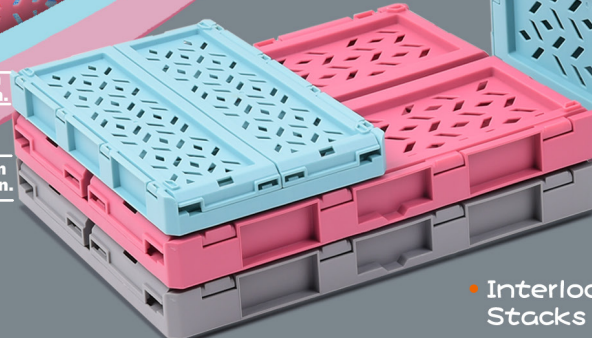

3 COLORS
PER ITEM

- Interlocking design
Stacks when assembled and collapsed

320231 Mini Knock-Down Crate - S

- 24 W x 16.4 D x 10.4 H cm (9-3/8 x 6-3/8 x 4 in.)
- When not in use, it collapses down to 2.8 cm H for compact storage
- Interlocking design – Stacks when assembled and collapsed
- Perfect for storing and transporting goods in the car, garage, home and office

NEW



Case Pack	Case Weight	Case Size	20' FCL	40' FCL	40' HQ
24	4.8 kg (10.5 lbs.)	36.5 x 28.5 x 38 cm (14-3/8 x 11-1/8 x 14-7/8 in.)	18,720	38,304	44,688



320233 Mini Knock-Down Crate - L

- 32.7 W x 24.6 D x 14.3 H cm (12-7/8 x 9-5/8 x 5-5/8 in.)
- When not in use, it collapses down to 3.6 cm H for compact storage
- Interlocking design – Stacks when assembled and collapsed
- Perfect for storing and transporting goods in the car, garage, home and office

NEW



Case Pack	Case Weight	Case Size	20' FCL	40' FCL	40' HQ
12	6.4 kg (14 lbs.)	35 x 26 x 43 cm (13-3/4 x 10-1/8 x 16-7/8 in.)	8,640	17,880	21,456





(Tools and assortments not included)

STAX ORGANIZER SERIES



320239 8 PC Stax Organizer Set

Case Pack	Case Weight	Case Size	20' FCL	40' FCL	40' HQ
9	22.5 kg (49.5 lbs.)	72 x 33 x 81 cm (28-1/3 x 13 x 31-4/5 in.)	1,449	2,898	3,303



6 942629 261896

320238 5 PC Stax Organizer Set

- 33 W x 24 D x 16 H cm (13 x 9-1/2 x 6-1/4 in.)
- Can be stackable



Case Pack	Case Weight	Case Size	20' FCL	40' FCL	40' HQ
12	15.9 kg (35 lbs.)	72 x 33 x 65 cm (28-1/3 x 13 x 25-1/2 in.)	2,340	4,788	5,520



320248 Stax Organizer Lid - Small

- 16.9 W x 11.8 D x 1 H cm (6-5/8 x 4-5/8 x 3/8 in.)
- A6 size
- Can be stackable
- Fits 320240, 320241 & 320242



Case Pack	Case Weight	Case Size	20' FCL	40' FCL
48	2.6 kg (5.7 lbs.)	24 x 17 x 17 cm (9-1/2 x 6-3/4 x 6-3/4 in.)	215,616	446,400



320240 Stax Organizer - Small

- 16.9 W x 11.8 D x 5.3 H cm (6-5/8 x 4-5/8 x 2 in.)
- A6 size
- Can be stackable



Case Pack	Case Weight	Case Size	20' FCL	40' FCL
12	1.5 kg (3.3 lbs.)	24 x 33 x 17 cm (9-1/2 x 13 x 6-3/4 in.)	27,984	58,128



320241 Stax Organizer With Divider - Small

- 16.9 W x 11.8 D x 5.3 H cm (6-5/8 x 4-5/8 x 2 in.)
- A6 size
- Can be stackable
- 4 Compartments



Case Pack	Case Weight	Case Size	20' FCL	40' FCL
12	1.7 kg (3.7 lbs.)	24 x 33 x 17 cm (9-1/2 x 13 x 6-3/4 in.)	27,984	58,128



320251 Stax Organizer Inner Tray - Small

- 15.1 W x 10.6 D x 4.3 H cm (6 x 4-1/8 x 1-3/4 in.)
- A6 size
- Fits 320240 & 320242



Case Pack	Case Weight	Case Size	20' FCL	40' FCL
12	1.5 kg (3.3 lbs.)	31 x 24 x 14 cm (12-1/5 x 9-1/2 x 5-1/2 in.)	41,172	84,792



320242 Deep stax Organizer - Small

- 16.9 W x 11.8 D x 10.8 H cm (6-5/8 x 4-5/8 x 4-1/4 in.)
- A6 size
- Can be stackable



Case Pack	Case Weight	Case Size	20' FCL	40' FCL
6	1.3 kg (2.8 lbs.)	24 x 17 x 33 cm (9-1/2 x 6-3/4 x 13 in.)	13,992	29,064





320249 Stax Organizer Lid - Medium

- 16.3 W x 24.2 D x 1 H cm (6-1/2 x 9-1/2 x 3/8 in.)
- A5 size
- Can be stackable
- Fits 320243, 320244 & 320245



Case Pack	Case Weight	Case Size	20' FCL	40' FCL
48	4.6 kg (10 lbs.)	24 x 33 x 17 cm (9-1/2 x 13 x 6-3/4 in.)	111,936	232,512



320243 Stax Organizer - Medium

- 16.3 W x 24.2 D x 5.3 H cm (6-1/2 x 9-1/2 x 2 in.)
- A5 size
- Can be stackable



Case Pack	Case Weight	Case Size	20' FCL	40' FCL
12	2.2 kg (4.8 lbs.)	24 x 33 x 34 cm (9-1/2 x 13 x 13-1/3 in.)	11,844	28,848



320244 Stax Organizer With Divider - Medium

- 16.3 W x 24.2 D x 5.3 H cm (6-1/2 x 9-1/2 x 2 in.)
- A5 size
- Can be stackable
- 5 Compartments



Case Pack	Case Weight	Case Size	20' FCL	40' FCL
12	2.5 kg (5.5 lbs.)	24 x 33 x 34 cm (9-1/2 x 13 x 13-1/3 in.)	11,844	28,848



320252 Stax Organizer Inner Tray - Medium

- 22.4 W x 15.1 D x 4.3 H cm (8-3/4 x 6 x 1-3/4 in.)
- A5 size
- Fits for 320243 & 320245



Case Pack	Case Weight	Case Size	20' FCL	40' FCL
12	2.2 kg (4.8 lbs.)	31 x 23 x 27 cm (12-1/5 x 9 x 10-3/5 in.)	19,416	40,416



320245 Deep stax Organizer - Medium

- 16.3 W x 24.2 D x 10.8 H cm (6-1/2 x 9-1/2 x 4-1/4 in.)
- A5 size
- Can be stackable



Case Pack	Case Weight	Case Size	20' FCL	40' FCL
6	1.8 kg (4 lbs.)	24 x 33 x 34 cm (9-1/2 x 13 x 13-1/3 in.)	5,922	14,424

320250 Stax Organizer Lid - Large

- 33.2 W x 23.6 D x 1 H cm (13 x 9-1/4 x 3/8 in.)
- A4 size
- Can be stackable
- Fits 320246 & 320247



Case Pack	Case Weight	Case Size	20' FCL	40' FCL
24	4.4 kg (9.6 lbs.)	24 x 33 x 17 cm (9-1/2 x 13 x 6-3/4 in.)	55,968	116,256



320246 Stax Organizer - Large

- 33.2 W x 23.6 D x 5.3 H cm (13 x 9-1/4 x 2 in.)
- A4 size
- Can be stackable



Case Pack	Case Weight	Case Size	20' FCL	40' FCL
6	2 kg (4.4 lbs.)	24 x 33 x 34 cm (9-1/2 x 13 x 13-1/3 in.)	5,922	14,424



320247 Stax Organizer With Divider - Large

- 33.2 W x 23.6 D x 5.3 H cm (13 x 9-1/4 x 2 in.)
- A4 size
- Can be stackable
- 11 Compartments



Case Pack	Case Weight	Case Size	20' FCL	40' FCL
6	2.4 kg (5.2 lbs.)	24 x 33 x 34 cm (9-1/2 x 13 x 13-1/3 in.)	5,922	14,424



320245 & 320249



320240 & 320248



320241 & 320248



320242 & 320248 & 320251



320246 & 320250



320247 & 320250

(Tools and assortments not included)



320244 & 320249



320243 & 320249



320070 Water Resistant Case (S)

- 18.8 W x 11.3 D x 4.7 H cm (7-3/8 x 4-3/8 x 1-3/4 in.)
- Water resistant: silicon o-ring, polycarbonate structure
- Cam-action latch
- Heavy duty wrist strap included
- Great for the jobsite, camping, fishing, outdoors



Case Pack	Case Weight	Case Size	20' FCL	40' FCL	40' HQ
12	4 kg (9 lbs.)	33 x 26.5 x 21.5 cm (13 x 10-1/2 x 8-1/2 in.)	20,160	41,160	46,800



Contents not included



Contents not included



Contents not included



320072 Water Resistant Case (L)

- 25.2 W x 15.7 D x 6.4 H cm (9-7/8 x 6-1/8 x 2-1/2 in.)
- Water resistant: silicon o-ring, polycarbonate structure
- TPR lining
- Cam-action latch
- Heavy duty wrist strap included
- Great for the jobsite, camping, fishing, outdoors



Case Pack	Case Weight	Case Size	20' FCL	40' FCL	40' HQ
12	7 kg (15 lbs.)	43 x 35 x 27.5 cm (17 x 13-3/4 x 11 in.)	8,892	18,456	20,796



Contents not included



Contents not included



Contents not included



320074 Water Resistant Case (D)

- 18.8 W x 11.3 D x 8.8 H cm (7-3/8 x 4-3/8 x 3-3/8 in.)
- Water resistant: silicon o-ring, polycarbonate structure
- Cam-action latch
- Heavy duty wrist strap included
- Great for the jobsite, camping, fishing, outdoors



Case Pack	Case Weight	Case Size	20' FCL	40' FCL
12	5 kg (11 lbs.)	38 x 38 x 22 cm (15 x 15 x 8-5/8 in.)	10,800	22,320



Contents not included

OTHER PLASTIC STORAGE

320090 Storage Clipboard

- 41 W x 26 D x 3.5 H cm (16-1/8 x 10-1/4 x 1-3/8 in.)
- Handy storage clipboard
- Protect documents and your personal goods
- Metric measuring increments



Case Pack	Case Weight	Case Size	20' FCL	40' FCL	40' HQ
12	8.9 kg (19.6 lbs.)	45 x 29 x 43 cm (17-3/4 x 11-1/2 x 17 in.)	6,240	12,780	15,336

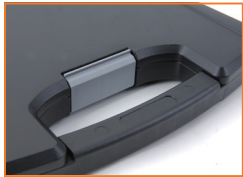

Business cards, stationary, A4 paper and tablet not included

320092 Clipboard Organizer

- 38.5 W x 28 D x 5 H cm (15-1/8 x 11 x 2 in.)
- Protective over-molded corners
- Compartments to organize business cards / stationary
- Heavy duty steel clip to hold A4 paper, files
- Document sleeves
- Tablet storage



Business cards, stationary, A4 paper and tablet not included



Case Pack	Case Weight	Case Size	20' FCL	40' FCL	40' HQ
8	9.7 kg (21.4 lbs.)	45 x 32 x 41 cm (17-3/4 x 12-5/8 x 16-1/8 in.)	3,920	8,120	9,280



320094 Mini Padboard

- 34.2 W x 26.6 D x 4.5 H cm (13-1/2 x 10-1/2 x 1-3/4 in.)
- Heavy duty steel clip for clamping A4 paper or files
- Organizers for name card and stationary
- Fit for various tablet
- Nylon pockets insides



Business cards, stationary, A4 paper and tablet not included



Case Pack	Case Weight	Case Size	20' FCL	40' FCL	40' HQ
8	6 kg (13 lbs.)	41 x 29 x 38 cm (16-1/8 x 11-1/2 x 15 in.)	5,440	11,264	12,672





320208 39 cm (15-3/8 in.) Plastic Tote

- 39 W x 28.5 D x 12.5 H cm (15-3/8 x 11-1/4 x 5 in.)
- Perforations for tools
- Ergonomic handle
- Can be stacked



Case Pack	Case Weight	Case Size	20' FCL	40' FCL
48	15.7 kg (35 lbs.)	59.5 x 41 x 47.5 cm (23-1/2 x 16 x 18-3/4 in.)	12,240	25,920



320200 49.6 cm (19-1/2 in.) Plastic Tote Tray

- 49.6 W x 33.6 D x 22.7 H cm (19-1/2 x 13-1/4 x 9 in.)
- Extra deep tray
- Slots for tools
- Ergonomic handle
- Ships nested in the master carton



Case Pack	Case Weight	Case Size	20' FCL	40' FCL	40' HQ
22	20.3 kg (44.8 lbs.)	52 x 37 x 93 cm (20-1/2 x 14-1/2 x 36-5/8 in.)	3,168	6,600	7,700



320202 50 cm (19-1/2 in.) Plastic Tote Tray

- 50 W x 35 D x 22.2 H cm (19-1/2 x 13-3/4 x 8-3/4 in.)
- Extra deep tray
- Slots for tools
- Ergonomic aluminum handle
- Ships nested in the master carton



Case Pack	Case Weight	Case Size	20' FCL	40' FCL	40' HQ
22	26.1 kg (57.5 lbs.)	52 x 37 x 96 cm (20-1/2 x 14-1/2 x 37-3/4 in.)	3,168	6,336	7,392



320206 50 cm (19-5/8 in.) Tool Tote with 2PC Removable Organizers

- 50 W x 35 D x 25 H cm (19-5/8 x 13-3/4 x 9-3/4 in.)
- 2 x Removable organizers
- Perforations for tool storage



Case Pack	Case Weight	Case Size	20' FCL	40' FCL
8	13 kg (27 lbs.)	52 x 37 x 76 cm (20-1/2 x 14-1/2 x 30 in.)	1,664	3,464



Tools & accessories not included

320212 16L Multi-purpose Tool Bucket

- 42.9 W x 30.8 D x 25.8 H cm (16-7/8 x 12-1/8 x 10-1/8 in.)
- Ergonomic, comfort-grip handle
- Contoured back side for comfortable carrying
- Internal and external measurement markings
- Integrated tool holders

Loading
50 kg
Capacity



Case Pack	Case Weight	Case Size	20' FCL	40' FCL	40' HQ
12	15.5 kg (34 lbs.)	45 x 36 x 82 cm (17-3/4 x 14-1/8 x 32-1/4 in.)	2,520	5,184	6,048



16L

OTHER PLASTIC STORAGE

320210 Tool Storage Rail

- 61 W x 7.2 D x 15.2 H cm (24 x 2-7/8 x 6 in.)
- Wall mountable (hardware not included)
- 91 Tool slots

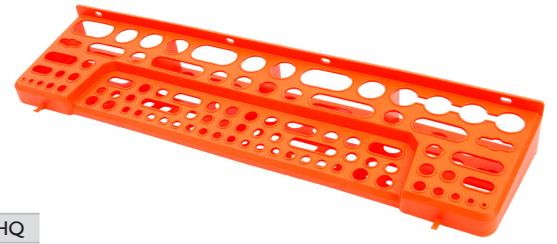

Inner Pack	Case Pack	Case Weight	Case Size	20' FCL	40' FCL	40' HQ
9	36	11 kg (24.3 lbs.)	64 x 45 x 69 cm (25-1/4 x 17-3/4 x 27-1/8 in.)	3,360	10,368	11,664

320216 39.7 cm (15-5/8 in.) Flexi Tote

- 39.7 W x 22.5 D x 35.5 H cm (15-5/8 x 8-3/4 x 14 in.)
- LDPE material
- Multi-purpose
- Shoulder strap



Case Pack	Case Weight	Case Size	20' FCL	40' FCL	40' HQ
16	15.2 kg (33.5 lbs.)	41 x 41 x 87 cm (16-1/8 x 16-1/8 x 34-1/2 in.)	2,720	5,680	6,960

320218 57 cm (22-1/2 in.) Flexi Tote

- 57 W x 30 D x 24.5 H cm (22-1/2 x 11-3/4 x 9-5/8 in.)
- LDPE material
- Aluminum handle
- Comfortable and convenient carryable gear
- Flexible and ergonomically design



Case Pack	Case Weight	Case Size	20' FCL	40' FCL	40' HQ
16	24.6 kg (54.2 lbs.)	63 x 33 x 102 cm (24-3/4 x 13 x 40-1/8 in.)	2,240	4,704	5,376

320254 14L Multi-purpose Storage Bin

- 36.6 W x 19.1 D x 41.6 H cm (14-3/8 x 7-1/2 x 16-3/8 in.)
- Comfort grip carry handle
- Easy clip lid
- Suitable for storing a variety of contents



Case Pack	Case Weight	Case Size	20' FCL	40' FCL	40' HQ
6	7.2 kg (16 lbs.)	40 x 39 x 58 cm (15-3/4 x 15-1/4 x 22-3/4 in.)	1,680	3,600	4,212

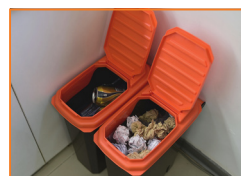



Tools & accessories not included

32L



320232 32L Knock-down Storage Crate

- 50.5 W x 33.5 D x 22 H cm (19-7/8 x 13-1/8 x 8-5/8 in.)
- When not in use, it collapses down to 4.3cm H for compact storage
- Interlocking design – Stacks when assembled and collapsed
- Perfect for storing and transporting goods in the car, garage, home and office



Case Pack	Case Weight	Case Size	20' FCL	40' FCL	40' HQ
32	22.9 kg (50.5 lbs.)	69 x 52.5 x 64 cm (27-1/8 x 20-5/8 x 25-1/8 in.)	3,360	7,008	9,344



Tools & accessories not included

OTHER PLASTIC STORAGE



Tools & accessories not included

320230 25L Heavy Duty Knock Down Crate

- 48 W x 35 D x 18.3 H cm (18-7/8 x 13-3/4 x 7-1/8 in.)
- When not in use, it collapses down to 4.7 cm H for compact storage
- Interlocking design – stacks when assembled and collapsed
- Perfect for storing and transporting goods in the car, garage, home and office



Case Pack	Case Weight	Case Size	20' FCL	40' FCL	40' HQ
12	17.5 kg (38.6 lbs.)	50 x 37 x 58 cm (19-5/8 x 14-1/4 x 22-7/8 in.)	3,168	6,912	8,064



Tools & accessories not included

25 L



320235 43L Heavy Duty Knock Down Crate

NEW

- 60 W x 40 D x 22.5 H cm (23-5/8 x 15-3/4 x 8-3/4 in.)
- When not in use, it collapses down to 5.5 cm H for compact storage
- Interlocking design – Stacks when assembled and collapsed
- Perfect for storing and transporting goods in the car, garage, home and office



Case Pack	Case Weight	Case Size	20' FCL	40' FCL	40' HQ
12	27 kg (60 lbs.)	62 x 42 x 63 cm (24-3/8 x 16-1/2 x 24-1/2 in.)	2,100	4,440	4,992

43 L



Three Step Guide>>>

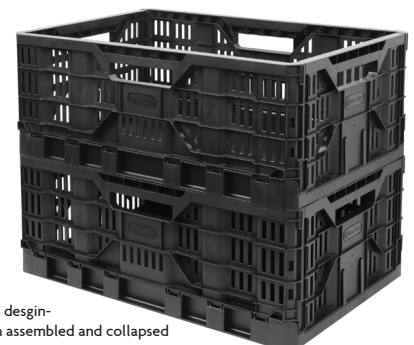

Interlocking design - Stacks when assembled and collapsed



320900 18 cm (7 in.) Mini Tool Box - Black

- 18 W x 8.9 D x 8.3 H cm (7 x 3-1/2 x 3-1/4 in.)
- Mini size for small parts storage



Case Pack	Case Weight	Case Size	20' FCL	40' FCL
90	9.3 kg (20 lbs.)	57 x 47 x 53 cm (22-1/2 x 18-1/2 x 20-7/8 in.)	17,280	36,000



Assortments not included



320901 18 cm (7 in.) Mini Tool Box - Colored

- 18 W x 8.9 D x 8.3 H cm (7 x 3-1/2 x 3-1/4 in.)
- Mini size for small parts storage



Case Pack	Case Weight	Case Size	20' FCL	40' FCL
90	9.3 kg (20 lbs.)	57 x 47 x 53 cm (22-1/2 x 18-1/2 x 20-7/8 in.)	17,280	36,000



Assortments not included



320104 30.5 cm (12 in.) Plastic Tool Box

- 30.5 W x 15 D x 10 H cm (12 x 5-7/8 x 4 in.)



Case Pack	Case Weight	Case Size	20' FCL	40' FCL	40' HQ
8	3.2 kg (7 lbs.)	33 x 32 x 43 cm (13 x 12-5/8 x 17 in.)	5,264	10,864	12,416



320105 38 cm (15 in.) Plastic Tool Box

- 38 W x 20 D x 16.5 H cm (15 x 8 x 6-1/2 in.)
- Lift out carry trays



Case Pack	Case Weight	Case Size	20' FCL	40' FCL	40' HQ
4	4.4 kg (9.7 lbs.)	43 x 41 x 37 cm (17 x 16-1/8 x 12-1/4 in.)	1,680	3,480	4,060



320106 2 PC Plastic Tool Box Set

- 38 W x 20 D x 16.5 H cm (15 x 8 x 6-1/2 in.)
- 30.5 W x 15 D x 10 H cm (12 x 5-7/8 x 4 in.)
- Lift out carry tray
- Built-in organization compartments



Case Pack	Case Weight	Case Size	20' FCL	40' FCL	40' HQ
4	5.5 kg (12 lbs.)	43 x 41 x 37 cm (17 x 16-1/8 x 12-1/4 in.)	1,680	3,480	4,060

OTHER PLASTIC STORAGE

320309 33 cm (13 in.) Multifunction Tool Box

- 33 W x 20 D x 15.8 H cm (13 x 7-7/8 x 6-1/4 in.)
- Two cantilever storage trays
- Bulk storage base
- Great for storage of tools, hardware, fishing tackle and small parts.



Case Pack	Case Weight	Case Size	20' FCL	40' FCL	40'HQ
4	5.5 kg (12 lbs.)	43 x 31 x 37 cm (17 x 16 x 12-1/4 in.)	2,136	4,464	5,208



320311 45 cm (17-3/4 in.) Multifunction Tool Box

- 45 W x 22 D x 21.3 H cm (17-3/4 x 8-5/8 x 8-3/8 in.)
- Three cantilever storage trays
- Bulk storage base
- Great for storage of tools, hardware, fishing tackle and small parts.



Case Pack	Case Weight	Case Size	20' FCL	40' FCL	40'HQ
4	7.9 kg (17.4 lbs.)	48 x 48 x 44 cm (18-7/8 x 18-7/8 x 17-1/2 in.)	1,008	2,096	2,620



320602 Double-sided Organizer

- Overall size: 34 W x 31 D x 13 H cm (13-3/8 x 12-1/4 x 5-1/8 in.)
- Box size: 10.5 W x 8 D x 6.5 H cm (4-1/8 x 3-1/8 x 2-1/2 in.)
- 21 W x 8 D x 6.5 H cm (8-1/4 x 3-1/8 x 2-1/2 in.)
- Double-sided box set
- 16pc Removable organizers
- Organization easily and carry together conveniently

Bin 1

Bin 2



14 x

2 x

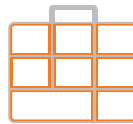

Case Pack	Case Weight	Case Size	20' FCL	40' FCL	40' HQ
8	13.3 kg (29 lbs.)	70 x 34 x 55 cm (27-1/2 x 13-3/8 x 21-5/8 in.)	1,632	3,360	3,808



Tools & accessories not included



Tools & accessories not included

320352 Storage Step Stool

- 50.8 W x 40.6 D x 31.8 H cm (20 x 16 x 12-1/2 in.)
- Sturdy construction
- Heavy duty steel latch
- Slide out drawer
- Integrated carry handle
- Great for storage of tools, hardware and accessories



Case Pack	Case Weight	Case Size	20' FCL	40' FCL	40'HQ
2	8.4 kg (18.5 lbs.)	53 x 42.5 x 66 cm (20-7/8 x 16-3/4 x 26 in.)	370	760	912



Tools & accessories not included



Tools & accessories not included





320624 40L Stacking Storage Crate

- 56.6 W x 40.4 D x 35.5 H cm (22-1/4 x 16 x 14 in.)
- Can be stackable
- Large storage capacity
- Wall mountable (hardware not included)
- Ideal for use in the garage, basement, utility room or play room
- Loading capacity per bin : 30 kg(66 lbs.)



Can be nested



Tool & accessories not included

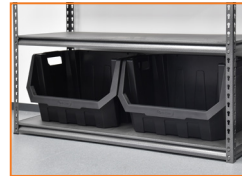

(329010B)



Case Pack	Case Weight	Case Size	20' FCL	40' FCL	40' HQ
12	24.8 kg (54.7 lbs.)	58 x 53 x 96 cm (22-7/8 x 20-7/8 x 37-7/8 in.)	1,152	2,304	2,880



320625 60L Stacking Storage Crate

- 45.5 W x 58.4 D x 40.2 H cm (18 x 23 x 15-3/4 in.)
- Can be stackable
- Large storage capacity
- Wall mountable (hardware not included)
- Ideal for use in the garage, basement, utility room or play room
- Loading capacity per bin : 40 kg(88 lbs.)



Can be nested



Tool & accessories not included



(329050B)



Case Pack	Case Weight	Case Size	20' FCL	40' FCL	40' HQ
6	16.7 kg (36.8 lbs.)	65 x 48 x 69 cm (25-5/8 x 18-7/8 x 27-1/8 in.)	756	1,548	1,620

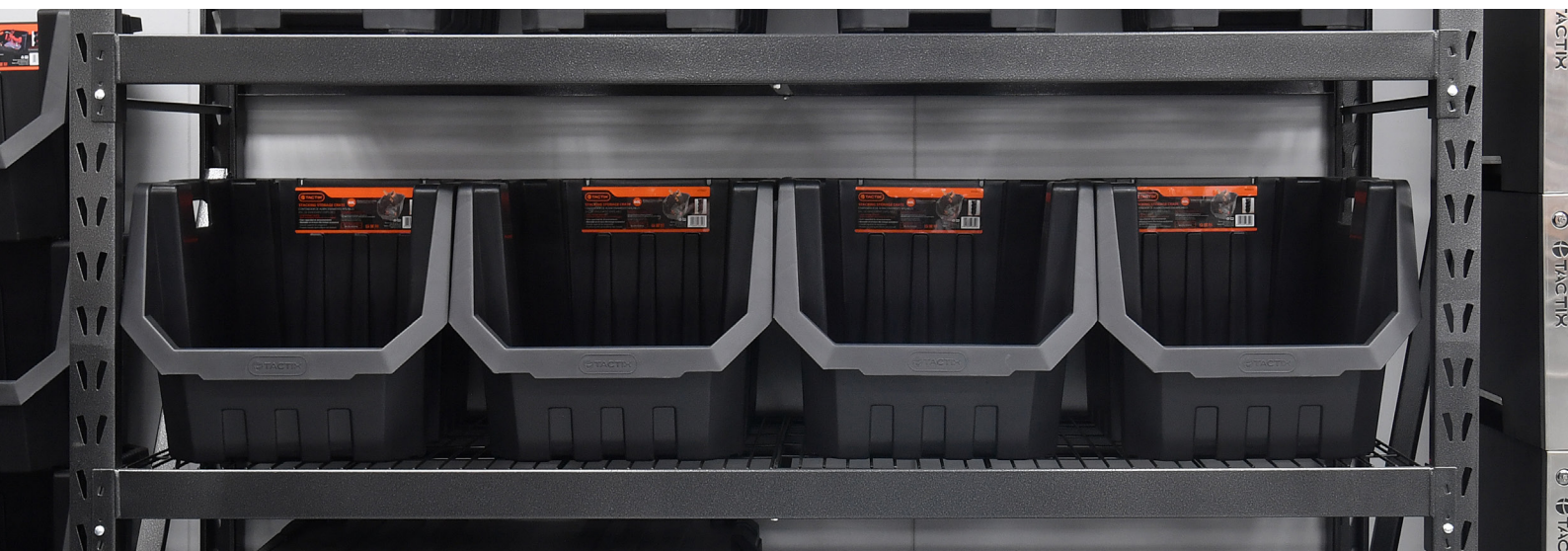

METAL PORTABLE TOOL BOX

321100 51 cm (20 in.) Steel Tool Box

- All-steel construction
- 51 W x 20.5 D x 23 H cm (20 x 8 x 9 in.)
- Comfort-grip top handle
- Heavy-duty steel drawbolt latches
- Full-length piano hinge
- Includes metal tote tray



Case Pack	Case Weight	Case Size	20' FCL	40' FCL
1	6.2 kg (14 lbs.)	52 x 25 x 28 cm (20-1/2 x 10 x 11 in.)	816	1,704



321101 61 cm (24 in.) Steel Tool Box

- All-steel construction
- 61 W x 24 D x 24 H cm (24 x 9-1/2 x 9-1/2 in.)
- Comfort-grip top handle
- Heavy-duty steel drawbolt latches
- Full-length piano hinge
- Includes metal tote tray



Case Pack	Case Weight	Case Size	20' FCL	40' FCL
1	9.5 kg (21 lbs.)	68 x 28 x 29 cm (26-3/4 x 11 x 11-1/2 in.)	536	1,112



321102 52 cm (20-1/2 in.) 3-Drawer Steel Tool Box

- All-steel construction
- 52 W x 23 D x 31 H cm (20-1/2 x 9 x 12-1/4 in.)
- Comfort-grip top handle
- Heavy-duty steel drawbolt latches
- Full-length piano hinge
- Full-width aluminum drawer pulls
- Full-extension ball-bearing drawer slides
- With EVA pad and foam protection



Case Pack	Case Weight	Case Size	20' FCL	40' FCL
1	10.5 kg (23 lbs.)	54 x 26 x 35 cm (21-1/4 x 10-1/4 x 13-3/4 in.)	528	1,104



321103 52 cm (20-1/2 in.) 4-Drawer Steel Tool Box

- All-steel construction
- 52 W x 23 D x 38 H cm (20-1/2 x 9 x 15 in.)
- Comfort-grip top handle
- Heavy-duty steel drawbolt latches
- Full-length piano hinge
- Full-width aluminum drawer pulls
- Full-extension ball-bearing drawer sliders
- With EVA pad and foam protection



Case Pack	Case Weight	Case Size	20' FCL	40' FCL
1	12.5 kg (28 lbs.)	54 x 26 x 41 cm (21 x 10-1/4 x 16-1/8 in.)	440	920





321109 38 cm (15 in.) Steel Gadget Box

- 38 W x 15 D x 10 H cm (15 x 5-7/8 x 3-7/8 in.)
- 0.021 Cubic meters (1,296 cubic inches) capacity
- All-steel construction
- Comfort-grip handle for easy portability



Case Pack	Case Weight	Case Size	20' FCL	40' FCL
1	1.5 kg (3.3 lbs.)	40 x 19 x 13 cm (16 x 8 x 5 in.)	3,150	6,588



321110 40 cm (15-3/4 in.) Steel Hip Roof Box

- 40 W x 18 D x 20 H cm (15-3/4 x 7 x 7-7/8 in.)
- 0.027 Cubic meters (1,641 cubic inches) capacity
- All-steel construction
- Comfort-grip handle for easy portability



Case Pack	Case Weight	Case Size	20' FCL	40' FCL
1	2.8 kg (6.2 lbs.)	42.5 x 22 x 22 cm (16-3/4 x 9 x 9 in.)	1,350	2,750



321111 47 cm (18-1/2 in.) 2-Drawer Steel Tool Box

- 47 W x 22 D x 26 H cm (18-1/2 x 8-5/8 x 10-1/4 in.)
- 0.046 Cubic meters (2,799 cubic inches) capacity
- All-steel construction
- Comfort-grip handle for easy portability



Case Pack	Case Weight	Case Size	20' FCL	40' FCL
1	8 kg (17.6 lbs.)	48 x 25 x 29 cm (19 x 10 x 12 in.)	864	1,800



321112 38.5 cm (15-1/8 in.) Steel Tool Box

- 38.5 W x 16 D x 13 H cm (15-1/8 x 6-1/4 x 5-1/8)
- All-steel construction
- Comfort-grip handle for easy portability



Case Pack	Case Weight	Case Size	20' FCL	40' FCL
6	9.8 kg (21.6 lbs.)	79 x 57 x 16 cm (31 x 22-1/2 x 6-1/4 in.)	2,352	5,040



321113 46.5 cm (18-1/4 in.) Steel Tool Box With 1 Tray

- 46.5 W x 21 D x 17 H cm (18-1/4 x 8-1/4 x 6-3/4 in.)
- All-steel construction
- Comfort-grip handle for easy portability
- Includes 1 metal tray



Case Pack	Case Weight	Case Size	20' FCL	40' FCL
4	12.5 kg (27.6 lbs.)	94 x 48 x 21 cm (37 x 19 x 8-1/4 in.)	1,056	2,200



321114 46.5 cm (18-1/4 in.) Steel Tool Box With 5 Tray Cantilever

- 46.5 W x 21 D x 23.5 H cm (18-1/4 x 8-1/4 x 9-1/4 in.)
- All-steel construction
- Comfort-grip handle for easy portability
- 4 Trays with cantilever function



Case Pack	Case Weight	Case Size	20' FCL	40' FCL
4	20.5 kg (45.2 lbs.)	94 x 49 x 28 cm (37 x 19 x 11 in.)	768	1,600

METAL PORTABLE TOOL BOX

321220 45.7 cm (18 in.) 1-Drawer Tool Box

- 45.7 W x 20.3 D x 11 H cm (18 x 8 x 4-3/8 in.)
- All-steel construction
- Comfortable tubular steel handle



Case Pack	Case Weight	Case Size	20' FCL	40' FCL
1	2.8 kg (6 lbs.)	50 x 21 x 15 cm (19-1/2 x 8-1/4 x 6 in.)	1,890	3,960



321221 45.7 cm (18 in.) 3-Drawer Tool Box

- 45.7 W x 20.3 D x 16 H cm (18 x 8 x 6-1/4 in.)
- All-steel construction
- Comfortable tubular steel handle

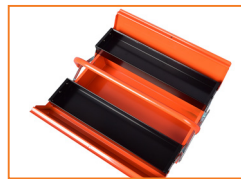

Case Pack	Case Weight	Case Size	20' FCL	40' FCL
1	3.8 kg (8 lbs.)	50 x 21 x 21 cm (19-1/2 x 8-1/4 x 8-1/4 in.)	1,386	2,904



321222 45.7 cm (18 in.) 5-Drawer Tool Box

- 45.7 W x 20.3 D x 21 H cm (18 x 8 x 8-1/4 in.)
- All-steel construction
- Comfortable tubular steel handle



Case Pack	Case Weight	Case Size	20' FCL	40' FCL
1	4.9 kg (11 lbs.)	50 x 21 x 26 cm (19-1/2 x 8-1/4 x 10-1/4 in.)	1,134	2,376



321210 54.8 cm (21-1/2 in.) Steel Tool Box

- 54.8 W x 24 D x 24.2 H cm (21-1/2 x 9-1/2 x 9-1/2 in.)
- All steel construction
- Large interior space for all your tool storage needs
- One-hand latch operation for ease of use
- Ergonomic long handle to balance the load



Case Pack	Case Weight	Case Size	20' FCL	40' FCL
1	5.1 kg (11 lbs.)	55 x 27 x 26 cm (21-1/2 x 10-1/2 x 10-1/4 in.)	720	1,494



321212 54.8 cm (21-1/2 in.) Steel Tool Box

- 54.8 W x 24 D x 24.2 H cm (21-1/2 x 9-1/2 x 9-1/2 in.)
- All steel construction
- Large interior space for all your tool storage needs
- One-hand latch operation for ease of use
- Ergonomic long handle to balance the load
- Ball bearing drawer slide



Tools not included



Case Pack	Case Weight	Case Size	20' FCL	40' FCL
1	7.5 kg (17 lbs.)	55 x 27 x 26 cm (21-1/2 x 10-1/2 x 10-1/4 in.)	720	1,494





321700 45 cm (17-5/8 in.) Aluminum Tool Box

- 45 W x 33 D x 15 H cm (17-5/8 x 13 x 5-7/8 in.)
- Chromed latch with lock
- Pocket for tool storage
- Adjustable dividers for easy storage



Case Pack	Case Weight	Case Size	20' FCL	40' FCL	40' HQ
4	10.6 kg (23 lbs.)	49 x 64 x 37 cm (19-1/4 x 25-1/8 x 14-1/2 in.)	960	2,016	2,352



321702 45 cm (17-5/8 in.) Aluminum Tool Box With Foam Inserts

- 45 W x 33 D x 15 H cm (17-5/8 x 13 x 5-7/8 in.)
- Dial lock
- Heavy-duty handle
- Removable foam inserts for easy storage



Case Pack	Case Weight	Case Size	20' FCL	40' FCL	40' HQ
4	10.4 kg (23 lbs.)	49 x 64 x 37 cm (19-1/4 x 25-1/8 x 14-1/2 in.)	960	2,016	2,352



321704 35.5 cm (14 in.) Aluminum Tool Box With Foam Inserts

- 35.5 W x 29 D x 13 H cm (14 x 11-3/8 x 5-1/8 in.)
- Chromed latch with lock
- Heavy-duty handle
- Removable foam inserts for easy storage



Case Pack	Case Weight	Case Size	20' FCL	40' FCL	40' HQ
5	9.8 kg (22 lbs.)	40 x 69 x 34 cm (15-3/4 x 27-1/8 x 13-3/8 in.)	1,380	2,910	3,395



321706 45 cm (17-5/8 in.) Aluminum Cantilever Tool Box

- 45 W x 22.5 D x 29.5 H cm (17-5/8 x 8-7/8 x 11-5/8 in.)
- Cantilever function
- Heavy-duty handle
- Adjustable dividers for easy storage
- Chromed cam-action latch with lock



Case Pack	Case Weight	Case Size	20' FCL	40' FCL	40' HQ
3	11.8 kg (26 lbs.)	49 x 72 x 34 cm (19-1/4 x 28-1/4 x 13-3/8 in.)	630	1,314	1,533

METAL PORTABLE TOOL BOX

321310 4-Digit Combination Code Wall Mount Key Safe

NEW

- 8.8 W x 4 D x 12.2 H cm (3-3/8 x 1-1/2 x 4-3/4 in.)
- Large space enables secure storage of up to house keys, car keys, large keys and so on
- The key lock box adopts hard aluminum alloy for durability
- Slide away shutter conceals dials and offers protection from weather
- Adjustable 4-digit combination locks offers up to 10,000 different combinations
- Easy to use and easy to install
- Wall mount (hardware included)



**4
DIGIT**



Case Pack	Case Weight	Case Size	20' FCL	40' FCL	40' HQ
24	14 kg (31 lbs.)	42 x 40 x 20 cm (16-1/2 x 15-3/4 x 7-3/4 in.)	18,480	39,600	46,800



Contents not included

321312 Digital Wall Mount Key Safe

NEW

- 6.5 W x 10.5 D x 10.5 H cm (2-1/2 x 4-1/8 x 4-1/8 in.)
- Secure Storage for Spare keys
- Digital combination lock
- Can fit up to 6 keys
- Set your personal code
- Can mount to the wall (All fixings included)



**10
DIGIT**



Case Pack	Case Weight	Case Size	20' FCL	40' FCL	40' HQ
24	15 kg (33 lbs.)	36 x 43 x 20 cm (14-1/8 x 16-7/8 x 7-7/8 in.)	22,440	46,728	46,800



Contents not included

321314 Portable Key Safe

NEW

- 6 W x 15 D x 4.5 H cm (2-3/8 x 5-7/8 x 1-3/4 in.)
- Secure Storage for Spare keys
- Digital combination lock
- Can fit up to 4 keys
- Set your personal code
- Can secure to numerous fixtures



**10
DIGIT**



Case Pack	Case Weight	Case Size	20' FCL	40' FCL	40' HQ
24	11.5 kg (25 lbs.)	36 x 43 x 23 cm (14-1/8 x 16-7/8 x 9 in.)	20,400	42,480	46,800



Contents not included



326001 & 326004

326007 & 326008

326002 & 326005

A 326007 66 cm (26 in.) 5-Drawer Tool Chest
B 326008 68 cm (26-1/2 in.) 5-Drawer Tool Cabinet
C 326001 101 cm (40 in.) 8-Drawer Tool Chest
D 326004 102 cm (40-1/2 in.) 14-Drawer Tool Cabinet
E 326002 132 cm (52 in.) 10-Drawer Tool Chest
F 326005 133 cm (52-1/2 in.) 14-Drawer Tool Cabinet

Locking system

Gas lid lifts for easy opening of top lid

Chrome over-molded side handles

Heavy-duty 13 x 5 cm (5 x 2 in.) casters provide up to 1,000 lbs. load rating

Flush-mount push bar for easy cabinet movement

Heavy-duty full-extension ball-bearing drawers

Grease-resistant EVA drawer liners keeps tools in place

TOOL CHEST & CABINET

326007 66 cm (26 in.) Wide 5-Drawer Tool Chest

- 0.084 Cubic meters (5124 cubic inches) capacity
- 66 W x 40.5 D x 50 H cm (26 x 16 x 19-3/4 in.)
- 5 Drawers:
 - 4pc - 59 W x 37 D x 5 H cm (23-1/4 x 14-3/4 in. x 2 in.)
 - 1pc - 59 W x 37 D x 13.3 H cm (23-1/4 x 14-3/4 x 5-1/4 in.)



Case Pack	Pallet Pack	Case Weight	Pallet Size	20' FCL	40' FCL
1	3	34.1 kg (75 lbs.)	147 x 77 x 67 cm (57-3/4 x 30-1/4 x 26-3/8 in.)	90	216



Gas lid lifts for easy opening of top lid



Chrome over-molded side handles



Heavy-duty full-extension ball-bearing drawers

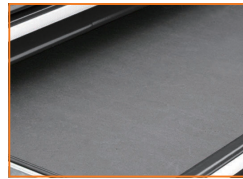

Grease-resistant EVA drawer liners keeps tools in place

326008 68 cm (26-1/2 in.) Wide 5-Drawer Tool Cabinet

- 0.131 Cubic meters (7999 cubic inches) capacity
- 68 W x 46 D x 87 H cm (26-1/2 x 18 x 34-1/4 in.) with castors
- 5 Drawers:
 - 1pc - 57 W x 41.5 D x 5 H cm (22-1/8 x 16-1/4 x 2 in.)
 - 2pc - 57 W x 41.5 D x 10 H cm (22-1/8 x 16-1/4 x 4 in.)
 - 2pc - 57 W x 41.5 D x 16 H cm (22-1/8 x 16-1/4 x 6-1/8 in.)



Case Pack	Pallet Pack	Case Weight	Pallet Size	20' FCL	40' FCL
1	1	51.7 kg (114 lbs.)	77 x 53 x 89 cm (30-1/4 x 20-7/8 x 35 in.)	66	132



326009 68 cm (26-1/2 in.) Wide 7-Drawer Tool Cabinet

- 0.172 Cubic meters (10499 cubic inches) capacity
- 68 W x 46 D x 102 H cm (26-1/2 x 18 x 40-1/8 in.) with castors
- 7 Drawers:
 - 4pc - 57 W x 41.5 D x 8 H cm (22-1/4 x 16-1/4 x 3-1/4 in.)
 - 1pc - 57 W x 41.5 D x 10.5 H cm (22-1/4 x 16-1/4 x 4-1/8 in.)
 - 2pc - 57 W x 41.5 D x 16 H cm (22-1/4 x 16-1/4 x 6-1/4 in.)



Case Pack	Pallet Pack	Case Weight	Pallet Size	20' FCL	40' FCL
1	1	57.9 kg (128 lbs.)	76 x 52 x 104 cm (30 x 20-1/2 x 41 in.)	66	132



Flush-mount push bar for easy cabinet movement

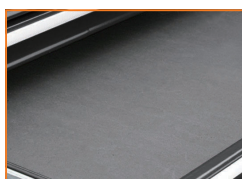

Grease-resistant EVA drawer liners keeps tools in place



Heavy-duty 13 x 5 cm (5 x 2 in.) castors provide up to 1,000 lbs. load rating



326001 101 cm (40 in.) 8-Drawer Tool Chest

- 101 W x 40 D x 55 H cm (40 x 16 x 21-1/2 in.)
- 0.149 Cubic meters (9,116 cubic inches) capacity
- 8 Drawers:
 - 5pc - 59 W x 37 D x 8 H cm (23-1/4 x 14-3/4 x 3 in.)
 - 3pc - 28 W x 37 D x 13 H cm (11 x 14-3/4 x 5-1/8 in.)



Case Pack	Pallet Pack	Case Weight	Pallet Size	20' FCL	40' FCL
1	1	65.6 kg (145 lbs.)	110 x 47 x 72.5 cm (43-1/4 x 18-1/2 x 28-1/2 in.)	72	144



Gas lid lifts for easy opening of top lid



Chrome over-molded side handles



Heavy-duty full-extension ball-bearing drawers



Grease-resistant EVA drawer liners keeps tools in place



326004 102 cm (40-1/2 in.) 14-Drawer Tool Cabinet

- 102 W x 46 D x 102 H cm (40-1/2 x 18 x 40-1/4 in.) with castors
- 0.246 Cubic meters (15,050 cubic inches) capacity
- MDF cabinet top included
- 14 Drawers:
 - 1pc - 59 W x 41.5 D x 11 H cm (23-1/4 x 16-1/4 x 4-1/4 in.)
 - 6pc - 59 W x 41.5 D x 8 H cm (23-1/4 x 16-1/4 x 3 in.)
 - 1pc - 59 W x 41.5 D x 13.5 H cm (23-1/4 x 16-1/4 x 5-1/4 in.)
 - 1pc - 30 W x 41.5 D x 11.5 H cm (11-3/4 x 16-1/4 x 4-1/2 in.)
 - 4pc - 30 W x 41.5 D x 8 H cm (11-3/4 x 16-1/4 x 3 in.)
 - 1pc - 30 W x 41.5 D x 29.5 H cm (11-3/4 x 16-1/4 x 11-3/4 in.)



Case Pack	Pallet Pack	Case Weight	Pallet Size	20' FCL	40' FCL
1	1	111.8 kg (246 lbs.)	111.5 x 52.5 x 103 cm (44 x 20-1/2 x 40-1/2 in.)	40	88



Flush-mount push bar for easy cabinet movement

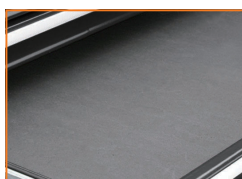

Grease-resistant EVA drawer liners keeps tools in place



Heavy-duty 13 x 5 cm (5 x 2 in.) casters provide up to 1,000 lbs. load rating



Heavy-duty full-extension ball-bearing drawers

TOOL CHEST & CABINET

326002 132 cm (52 in.) 10-Drawer Tool Chest

- 132 W x 40 D x 50 H cm (52 x 16 x 19-5/8 in.)
- 0.181 Cubic meters (11,070 cubic inches) capacity
- 10 Drawers:
 - 6pc - 58.5 W x 37 D x 5 H cm (23 x 14-3/4 x 2 in.)
 - 2pc - 58.5 W x 37 D x 8 H cm (23 x 14-3/4 x 3-1/8 in.)
 - 2pc - 58.5 W x 37 D x 11 H cm (23 x 14-3/4 x 4-1/4 in.)



Case Pack	Pallet Pack	Case Weight	Pallet Size	20' FCL	40' FCL
1	1	83 kg (183 lbs.)	140 x 48 x 66 cm (59 x 19 x 26 in.)	48	96



Gas lid lifts for easy opening of top lid



Chrome over-molded side handles



Heavy-duty full-extension ball-bearing drawers

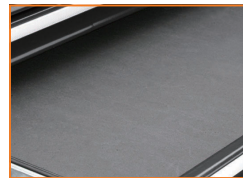

Grease-resistant EVA drawer liners keeps tools in place

326005 133 cm (52-1/2 in.) 14-Drawer Tool Cabinet

- 133 W x 46 D x 105 H cm (52-1/2 x 18 x 41-3/8 in.) with castors
- 0.349 Cubic meters (21,298 cubic inches) capacity
- MDF cabinet top included
- 14 Drawers:
 - 2pc - 58.5 W x 41.5 D x 5 H cm (23 x 16-1/4 x 2 in.)
 - 6pc - 58.5 W x 41.5 D x 8 H cm (23 x 16-1/4 x 3 in.)
 - 4pc - 58.5 W x 41.5 D x 10.5 H cm (23 x 16-1/4 x 4 in.)
 - 2pc - 58.5 W x 41.5 D x 24 H cm (23 x 16-1/4 x 9-1/2 in.)



Case Pack	Pallet Pack	Case Weight	Pallet Size	20' FCL	40' FCL
1	1	147 kg (324 lbs.)	142 x 53 x 108 cm (56 x 21 x 42-1/2 in.)	32	64



Flush-mount push bar for easy cabinet movement

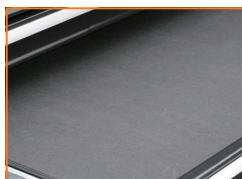

Grease-resistant EVA drawer liners keeps tools in place



Heavy-duty 13 x 5 cm (5 x 2 in.) casters provide up to 1,000 lbs. load rating



Heavy-duty full-extension ball-bearing drawers



326071 181 cm (71 in.) Wide Tool Chest

- 181 W x 55 D x 52 H cm (71 x 21-3/4 x 20-5/8 in.)
- 0.366 Cubic meters (22326 cubic inches) capacity
- Gas lid lifts for easy opening of top lid
- Ball-bearing drawer slides
- 10 Drawers
 - 4pc - 39.6 W x 50.9 D x 7.8 H cm (15-1/2 x 23-1/4 x 3 in.)
 - 2pc - 39.6 W x 50.9 D x 15.9 H cm (15-1/2 x 23-1/4 x 6-1/4 in.)
 - 4pc - 83.5 W x 50.9 D x 7.8 H cm (32-7/8 x 23-1/4 x 3 in.)



Case Pack	Pallet Pack	Case Weight	Pallet Size	20' FCL	40' FCL
1	1	143.6 kg (317 lbs.)	190.5 x 63 x 67 cm (75 x 24-3/4 x 26-1/4 in.)	27	54



326072 183 cm (72 in.) Wide Mobile Tool Cart

- 183 W x 61 D x 112 H cm (72 x 24 x 44 in.) with castors
- 0.84 Cubic meters (51,259 cubic inches) capacity
- Heavy duty handle
- Powder coated finish
- 20 Drawer
 - Left
 - 1pc - 129.5 W x 55.9 D x 9.5 H cm (51 x 22 x 3-3/4 in.)
 - 3pc - 39.7 W x 55.9 D x 6.7 H cm (15-5/8 x 22 x 2-5/8 in.)
 - 1pc - 39.7 W x 55.9 D x 12.7 H cm (15-5/8 x 22 x 5 in.)
 - 1pc - 39.7 W x 55.9 D x 32.7 H cm (15-5/8 x 22 x 12-7/8 in.)
 - Middle
 - 3pc - 83.5 W x 55.9 D x 6.7 H cm (32-7/8 x 22 x 2-5/8 in.)
 - 2pc - 83.5 W x 55.9 D x 12.7 H cm (32-7/8 x 22 x 5 in.)
 - 1pc - 83.5 W x 55.9 D x 19.7 H cm (32-7/8 x 22 x 7-3/4 in.)
 - Right
 - 5pc - 39.7 W x 55.9 D x 6.7 H cm (15-5/8 x 22 x 2-5/8 in.)
 - 2pc - 39.7 W x 55.9 D x 12.7 H cm (15-5/8 x 22 x 5 in.)
 - 1pc - 39.7 W x 55.9 D x 19.7 H cm (15-5/8 x 22 x 7-3/4 in.)



Case Pack	Pallet Pack	Case Weight	Pallet Size	20' FCL	40' HQ
1	1	296.5 kg (654 lbs.)	190 x 66 x 118 cm (75 x 26 x 46-1/2 in.)	-	36



Grease-resistant EVA top mat



Flush-mount push bar for easy cabinet movement



Heavy-duty full-extension ball-bearing drawers

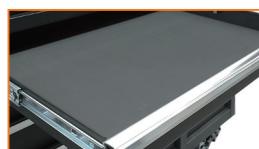

Grease-resistant EVA drawer liners keeps tools in place



15 x 5 cm (6 x 2 in.) casters provide up to 5,300 lbs. loading rating

NEXT GENERATION METAL TOOL STORAGE





326301 105.5 cm (41-1/2 in.) 7 Drawer Tool Chest

- 105.5 W x 45 D x 62.6 H cm (41-1/2 x 17-3/4 x 24-5/8 in.)
- 7 Drawers:
 - 2pc - 35.2 W x 40.8 D x 5 H cm (13-7/8 x 16 x 2 in.)
 - 1pc - 35.2 W x 40.8 D x 15.8 H cm (13-7/8 x 16 x 6-1/4 in.)
 - 2pc - 58.3 W x 40.8 D x 5 H cm (23 x 16 x 2 in.)
 - 2pc - 58.3 W x 40.8 D x 7.7 H cm (23 x 16 x 3 in.)



Case Pack	Pallet Pack	Case Weight	Pallet Size	20' FCL	40' FCL	40' HQ
1	1	78.2 kg (172 lbs.)	116 x 53 x 80.5 cm (45-5/8 x 20-7/8 x 31-5/8 in.)	44	88	132



326304 106.7 cm (42 in.) 12 Drawer Tool Cabinet

- 106.7 W x 46 D x 109.9 H cm (42 x 18-1/8 x 43-1/4 in.) with castors
- 12 Drawers:
 - 1pc - 98.6 W x 40.8 D x 13.1 H cm (38-3/4 x 16 x 5 in.)
 - 2pc - 35.2 W x 40.8 D x 5 H cm (13-7/8 x 16 x 2 in.)
 - 2pc - 35.2 W x 40.8 D x 10.4 H cm (13-7/8 x 16 x 4 in.)
 - 1pc - 35.2 W x 40.8 D x 34.7 H cm (13-7/8 x 16 x 13-5/8 in.)
 - 1pc - 59.1 W x 40.8 D x 5 H cm (23-1/4 x 16 x 2 in.)
 - 2pc - 59.1 W x 40.8 D x 7.7 H cm (23-1/4 x 16 x 3 in.)
 - 2pc - 59.1 W x 40.8 D x 10.4 H cm (23-1/4 x 16 x 4 in.)
 - 1pc - 59.1 W x 40.8 D x 23.9 H cm (23-1/4 x 16 x 9-3/8 in.)



Case Pack	Pallet Pack	Case Weight	Pallet Size	20' FCL	40' FCL
1	1	126.7 kg (279 lbs.)	116 x 53 x 109 cm (45-5/8 x 20-7/8 x 42-7/8 in.)	39	87



Main drawer

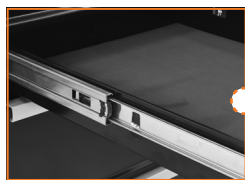

Ball bearing slides



Deep drawer



Heavy duty push bar

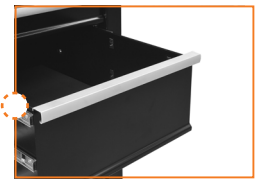

Heavy duty drawer



Heavy duty casters

TOOL CHEST & CABINET

326302 141 cm (55-1/2 in.) 5 Drawer Tool Chest

- 141 W x 50 D x 58 H cm (55-1/2 x 19-5/8 x 22-7/8 in.)
- 5 Drawers:
 - 2pc - 39.8 W x 45.8 D x 5 H cm (15-5/8 x 18 x 2 in.)
 - 1pc - 39.8 W x 45.8 D x 10.4 H cm (15-5/8 x 18 x 4 in.)
 - 2pc - 86.5 W x 45.8 D x 10.4 H cm (34 x 18 x 4 in.)



Case Pack	Pallet Pack	Case Weight	Pallet Size	20' FCL	40' FCL
1	1	92.4 kg (204 lbs.)	146 x 55 x 73 cm (27-1/2 x 21-5/8 x 29 in.)	44	88



326305 142.2 cm (56 in.) 11 Drawer Tool Cabinet

- 142.2 W x 51 D x 113 H cm (56 x 20 x 44-1/2 in.) with castors
- 11 Drawers:
 - 1pc - 132.3 W x 45.8 D x 13.1 H cm (52 x 18 x 5 in.)
 - 1pc - 39.8 W x 45.8 D x 7.7 H cm (15-5/8 x 18 x 3 in.)
 - 2pc - 39.8 W x 45.8 D x 13.1 H cm (15-5/8 x 18 x 5 in.)
 - 1pc - 39.8 W x 45.8 D x 29.8 H cm (15-5/8 x 18 x 11-3/4 in.)
 - 3pc - 87.3 W x 45.8 D x 7.7 H cm (34-3/8 x 18 x 3 in.)
 - 2pc - 87.3 W x 45.8 D x 10.4 H cm (34-3/8 x 18 x 4 in.)
 - 1pc - 87.3 W x 45.8 D x 19 H cm (34-3/8 x 18 x 7-1/2 in.)



Case Pack	Pallet Pack	Case Weight	Pallet Size	20' FCL	40' FCL	40' HQ
1	1	169.2 kg (373 lbs.)	149 x 57 x 117 cm (58-5/8 x 22-3/8 x 46 in.)	13	28	56



326307 66 cm (26 in.) 4 Drawer Tool Chest

- 66 W x 45 D x 62.6 H cm (26 x 17-3/4 x 24-5/8 in.)
- 4 Drawers:
 - 2pc - 58.3 W x 40.8 D x 5 H cm (23 x 16 x 2 in.)
 - 2pc - 58.3 W x 40.8 D x 7.7 H cm (23 x 16 x 3 in.)



Case Pack	Pallet Pack	Case Weight	Pallet Size	20' FCL	40' FCL	40' HQ
1	1	49.3 kg (109 lbs.)	75 x 52 x 79 cm (29-1/2 x 20-1/2 x 31 in.)	66	138	207



326308 67.2 cm (26-1/2 in.) 6 Drawer Tool Cabinet

- 67.2 W x 46 D x 108.4 H cm (26-1/2 x 18 x 42-5/8 in.) with castors
- 6 Drawers:
 - 1pc - 59.1 W x 40.8 D x 10.4 H cm (13-7/8 x 16 x 4 in.)
 - 1pc - 59.1 W x 40.8 D x 5 H cm (13-7/8 x 16 x 2 in.)
 - 2pc - 59.1 W x 40.8 D x 7.7 H cm (23 x 16 x 3 in.)
 - 1pc - 59.1 W x 40.8 D x 15.8 H cm (23 x 16 x 6-1/4 in.)
 - 1pc - 59.1 W x 40.8 D x 32 H cm (23 x 16 x 12-1/2 in.)



Case Pack	Pallet Pack	Case Weight	Pallet Size	20' FCL	40' FCL
1	1	71.8 kg (158 lbs.)	76 x 53 x 108 cm (30 x 20-7/8 x 42-1/2 in.)	66	132





326371 181.5 cm (71-1/2 in.) 4 Drawer Tool Chest

- 181.5 W x 55 D x 58 H cm (71-1/2 x 21-5/8 x 22-7/8 in.)
- 4 Drawers:
 - 1pc - 38.4 W x 50.6 D x 10.4 H cm (15 x 20 x 4 in.)
 - 2pc - 88.9 W x 50.6 D x 5 H cm (35-7/8 x 20 x 2 in.)
 - 1pc - 88.9 W x 50.6 D x 10.4 H cm (35 x 20 x 4 in.)



Case Pack	Pallet Pack	Case Weight	Pallet Size	20' FCL	40' FCL
1	1	127 kg (280 lbs.)	188 x 61 x 74 cm (74 x 24 x 29 in.)	27	57



326372 183 cm (72 in.) 12 Drawer Tool Cabinet

- 183 W x 56 x 113cm (72 x 22 x 44-1/2 in.) with castors
- 12 Drawers:
 - 1pc - 134.4 W x 50.6 D x 13.1 H cm (53 x 20 x 5 in.)
 - 2pc - 39.7 W x 50.6 D x 7.7 H cm (15-5/8 x 20 x 3 in.)
 - 1pc - 39.7 W x 50.6 D x 18.5 H cm (15-5/8 x 20 x 7-1/4 in.)
 - 1pc - 39.7 W x 50.6 D x 29.8 H cm (15-5/8 x 20 x 11-3/4 in.)
 - 3pc - 88.9 W x 50.6 D x 7.7 H cm (35 x 20 x 3 in.)
 - 2pc - 88.9 W x 50.6 D x 10.4 H cm (35 x 20 x 4 in.)
 - 1pc - 88.9 W x 50.6 D x 19 H cm (35 x 20 x 7-1/2 in.)
 - 1pc - 31.7 W x 50.6 D x 78.4 H cm (12-1/2 x 20 x 30-7/8 in.)



Case Pack	Pallet Pack	Case Weight	Pallet Size	20' FCL	40' FCL	40' HQ
1	1	245 kg (540 lbs.)	189 x 62 x 118 cm (74-1/2 x 24-1/2 x 46-1/2 in.)	9	19	38



1 Power tool locker 2 Secured storage 3 Drop-down power center 4 Heavy duty push bar

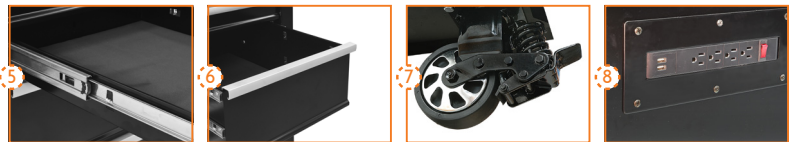

5 Ball bearing slides 6 Heavy duty drawer 7 Heavy duty casters 8 Power supply

326373 183 cm (72 in.) 12 Drawer Tool Cabinet With Stainless Steel Work Top

- 183 W x 56 D x 113 H cm (72 x 22 x 44-1/2 in.) with castors
- Stainless steel work top
- 1 x Chromed push bar
- 12 Drawers:
 - 1pc - 134.4 W x 50.6 D x 13.1 H cm (53 x 20 x 5 in.)
 - 2pc - 39.7 W x 50.6 D x 7.7 H cm (15-5/8 x 20 x 3 in.)
 - 1pc - 39.7 W x 50.6 D x 18.5 H cm (15-5/8 x 20 x 7-1/4 in.)
 - 1pc - 39.7 W x 50.6 D x 29.8 H cm (15-5/8 x 20 x 11-3/4 in.)
 - 3pc - 88.9 W x 50.6 D x 7.7 H cm (35 x 20 x 3 in.)
 - 2pc - 88.9 W x 50.6 D x 10.4 H cm (35 x 20 x 4 in.)
 - 1pc - 88.9 W x 50.6 D x 19 H cm (35 x 20 x 7-1/2 in.)
 - 1pc - 31.7 W x 50.6 D x 78.4 H cm (12-1/2 x 20 x 30-7/8 in.)



Case Pack	Pallet Pack	Case Weight	Pallet Size	20' FCL	40' FCL	40' HQ
1	1	300.7 kg (663 lbs.)	190 x 63 x 131 cm (74-3/4 x 24-3/4 x 51-1/2 in.)	9	19	37

TOOL CHEST & CABINET



- A** 326320 140 cm (56 in.) 10 Drawer Stainless Steel Tool Cabinet
- B** 326322 183 cm (72 in.) 15 Drawer Stainless Steel Tool Cabinet
- C** 326324 68 cm (26 in.) 5 Drawer Stainless Steel Tool Cabinet



38mm Hardwood benchtop



Key lockable



Durable 430 grade stainless steel



Heavy-duty stainless steel push bar



Full extension ball-bearing drawers



6 in. Heavy-duty swivel casters



326324 68 cm (26 in.) 5 Drawer Stainless Steel Tool Cabinet

NEW

- 68 W x 49 D x 95 H cm (26 x 19-1/4 x 37-3/8 in.) with castors
- Durable 430 grade stainless steel
- 5 Drawers:
 - 3pc - 56.9 W x 39.7 D x 6.4 H cm (22-3/8 x 15-5/8 x 2-1/2 in.)
 - 1pc - 56.9 W x 39.7 D x 14.3 H cm (22-3/8 x 15-5/8 x 5-5/8 in.)
 - 1pc - 56.9 W x 39.7 D x 22.2 H cm (22-3/8 x 15-5/8 x 8-3/4 in.)



Case Pack	Pallet Pack	Case Weight	Pallet Size	20' FCL	40' FCL	40' HQ
1	1	55 kg (121 lbs.)	74 x 54 x 86 cm (29-1/8 x 21-1/4 x 33-3/4 in.)	64	132	195



Key lockable



Heavy-duty stainless steel push bar



Full extension ball-bearing drawers



Heavy-duty swivel casters



326320 140 cm (56 in.) 10 Drawer Stainless Steel Tool Cabinet

NEW

- 140 W x 49 D x 95 H cm (56 x 19-1/4 x 37-3/8 in.) with castors
- Durable 430 grade stainless steel
- 10 Drawers:
 - 3pc - 37.6 W x 39.7 D x 6.4 H cm (14-1/2 x 15-5/8 x 2-1/2 in.)
 - 1pc - 37.6 W x 39.7 D x 14.3 H cm (14-1/2 x 15-5/8 x 5-5/8 in.)
 - 1pc - 37.6 W x 39.7 D x 22.2 H cm (14-1/2 x 15-5/8 x 8-3/4 in.)
 - 3pc - 85.8 W x 39.7 D x 6.4 H cm (33-3/4 x 15-5/8 x 2-1/2 in.)
 - 1pc - 85.8 W x 39.7 D x 14.3 H cm (33-3/4 x 15-5/8 x 5-5/8 in.)
 - 1pc - 85.8 W x 39.7 D x 22.2 H cm (33-3/4 x 15-5/8 x 8-3/4 in.)



Case Pack	Pallet Pack	Case Weight	Pallet Size	20' FCL	40' FCL	40' HQ
1	1	107 kg (235 lbs.)	145 x 54 x 86 cm (57 x 21-1/4 x 33-3/4 in.)	32	64	96



326322 183 cm (72 in.) 15 Drawer Stainless Steel Tool Cabinet

NEW

- 183 W x 49 D x 95 H cm (72 x 19-1/4 x 37-3/8 in.) with castors
- Durable 430 grade stainless steel
- 15 Drawers:
 - 6pc - 37.6 W x 39.7 D x 6.4 H cm (14-1/2 x 15-5/8 x 2-1/2 in.)
 - 2pc - 37.6 W x 39.7 D x 14.3 H cm (14-1/2 x 15-5/8 x 5-5/8 in.)
 - 2pc - 37.6 W x 39.7 D x 22.2 H cm (14-1/2 x 15-5/8 x 8-3/4 in.)
 - 3pc - 85.8 W x 39.7 D x 6.4 H cm (33-3/4 x 15-5/8 x 2-1/2 in.)
 - 1pc - 85.8 W x 39.7 D x 14.3 H cm (33-3/4 x 15-5/8 x 5-5/8 in.)
 - 1pc - 85.8 W x 39.7 D x 22.2 H cm (33-3/4 x 15-5/8 x 8-3/4 in.)



Case Pack	Pallet Pack	Case Weight	Pallet Size	20' FCL	40' FCL	40' HQ
1	1	138 kg (304 lbs.)	187 x 54 x 86 cm (73-5/8 x 21-1/4 x 33-7/8 in.)	24	48	72

TOOL CHEST & CABINET



- A** 326500 77 cm (30-1/2 in.) Tool Chest With 4 Drawers
- B** 326502 77.5 cm (30-1/2 in.) Tool Cabinet With 5 Drawers
- C** 326504 115 cm (45 in.) Tool Cabinet With 5 Drawers
- D** 326506 115 cm (45-1/2 in.) Tool Cabinet With 5 Drawers And 1 Door



Comfort-grip push bar for easy cabinet movement



Perforated side allows flexible organization of additional tools and accessories



Plastic corner for anti-shock

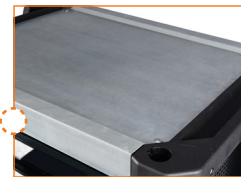

Galvanized steel work top



Heavy-duty full extension auto-retention ball bearing drawer slides



Anti-tilt safety mechanism



Heavy-duty 13 x 5 cm (5 x 2 in.) casters provide up to 1,000 lbs. load rating



4pc connector for affixing top and bottom cabinet

326500 77.5 cm (30-1/2 in.) Tool Chest With 4 Drawers

- 77.5 W x 53.5 D x 47 H cm (30-1/2 x 21 x 18-1/2 in.)
- 4 Drawers
- 3pc - 57 W x 42 D x 8 H cm (22-1/2 x 16-1/2 x 3-1/8 in.)
- 1pc - 57 W x 42 D x 13.5 H cm (22-1/2 x 16-1/2 x 5-1/4 in.)



Case Pack	Pallet Pack	Case Weight	Pallet Size	20' FCL	40' FCL
1	1	47 kg (104 lbs.)	87 x 53 x 70 cm (34-1/2 x 20-3/4 x 27-1/2 in.)	84	174

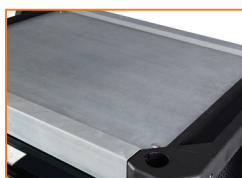

Galvanized steel work top



Heavy-duty full extension auto-retention ball bearing drawer slides



Comfort-grip push bar for easy cabinet movement



Plastic corner for anti-shock



326502 77.5 cm (30-1/2 in.) Tool Cabinet With 5 Drawers

- 77.5 W x 53.5 D x 102 H cm (30-1/2 x 21 x 40-1/8 in.) with castors
- 5 Drawers
- 2pc - 57 W x 42 D x 8 H cm (22-1/2 x 16-1/2 x 3-1/8 in.)
- 2pc - 57 W x 42 D x 13.5 H cm (22-1/2 x 16-1/2 x 5-1/4 in.)
- 1pc - 57 W x 42 D x 29.5 H cm (22-1/2 x 16-1/2 x 5-1/4 in.)



Case Pack	Pallet Pack	Case Weight	Pallet Size	20' FCL	40' FCL
1	1	80 kg (176 lbs.)	87 x 53 x 102 cm (34-1/2 x 20-7/8 x 40 in.)	56	116



Anti-tilt safety mechanism



Heavy-duty 13 x 5 cm (5 x 2 in.) casters provide up to 1,000 lbs. load rating



Perforated side allows flexible organization of additional tools and accessories



4pc Connector for affixing top and bottom cabinet

TOOL CHEST & CABINET

326506 115.5 cm (45-1/2 in.) Tool Cabinet With 5 Drawers And 1 Door

- 115.5 W x 53.5 D x 102 H cm (45-1/2 x 21 x 40-1/8 in.) with castors
- 5 Drawers
 - 2pc - 57 W x 42 D x 8 H cm (22-1/2 x 16-1/2 x 3-1/8 in.)
 - 2pc - 57 W x 42 D x 13.5 H cm (22-1/2 x 16-1/2 x 5-1/4 in.)
 - 1pc - 57 W x 42 D x 29.5 H cm (22-1/2 x 16-1/2 x 11-3/8 in.)



Case Pack	Pallet Pack	Case Weight	Pallet Size	20' FCL	40' FCL
1	1	109.4 kg (241 lbs.)	126 x 63 x 102 cm (49 x 25 x 40 in.)	26	56

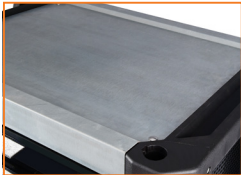

Galvanized steel work top



Anti-tilt safety mechanism



Heavy-duty 13 x 5 cm (5 x 2 in.) casters provide up to 1,000 lbs. load rating



Perforated side allows flexible organization of additional tools and accessories

326504 115.5 cm (45-1/2 in.) Tool Cabinet With 5 Drawers

- 115.5 W x 53.5 D x 102 H cm (45-1/2 x 21 x 40-1/8 in.) with castors
- 5 Drawers
 - 2pc - 95 W x 42 D x 8 H cm (37-1/2 x 16-1/2 x 3-1/8 in.)
 - 2pc - 95 W x 42 D x 13.5 H cm (37-1/2 x 16-1/2 x 5-1/4 in.)
 - 1pc - 95 W x 42 D x 29.5 H cm (37-1/2 x 16-1/2 x 11-3/8 in.)



Case Pack	Pallet Pack	Case Weight	Pallet Size	20' FCL	40' FCL
1	1	125 kg (276 lbs.)	126 x 63 x 102 cm (49 x 25 x 40 in.)	26	56



Galvanized steel work top



Anti-tilt safety mechanism



Heavy-duty 13 x 5 cm (5 x 2 in.) casters provide up to 1,000 lbs. load rating



Perforated side allows flexible organization of additional tools and accessories



326400 66 cm (26 in.) 5-Drawer Tool Chest

- 66 W x 30.5 D x 47 H cm (26 x 12 x 18-1/2 in.) with castors
- 0.06 Cubic meters (3,713 cubic inches) capacity
- 5 Drawers:
 - 1pc - 57 W x 27 D x 5 H cm (22-1/2 x 10-3/4 x 2 in.)
 - 1pc - 57 W x 27 D x 10 H cm (22-1/2 x 10-3/4 x 3-7/8 in.)



Case Pack	Pallet Pack	Case Weight	Pallet Size	20' FCL	40' FCL
1	3	24.1 kg (53 lbs.)	118 x 77 x 66 cm (46-1/2 x 30-1/4 x 26 in.)	117	270



326403 68 cm (26-1/2 in.) 5-Drawer Tool Cabinet

- 68 W x 46 D x 82 H cm (26-1/2 x 18 x 33-3/8 in.) with castors
- 0.131 Cubic meters (7,999 cubic inches) capacity
- 5 Drawers:
 - 1pc - 57 W x 41.5 D x 5 H cm (22-1/8 x 10-3/4 x 2 in.)
 - 2pc - 57 W x 41.5 D x 10 H cm (22-1/8 x 10-3/4 x 4 in.)
 - 2pc - 57 W x 41.5 D x 16 H cm (22-1/8 x 10-3/4 x 6-1/8 in.)



Case Pack	Pallet Pack	Case Weight	Pallet Size	20' FCL	40' FCL
1	1	46.9 kg (103 lbs.)	77 x 53 x 89 cm (30-1/4 x 20-7/8 x 35 in.)	64	132



• Locking lid bracket



• Ball-bearing drawer slides



• Drawer depth: 27 cm (10-3/4 in.)

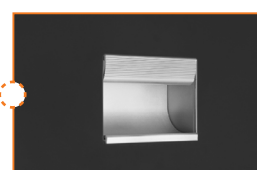

• Aluminum side handles



• Tubular steel push bar



• Heavy-duty 10 x 5 cm (4 x 2 in.) casters provide up to 750 lbs. load rating

TOOL CHEST & CABINET

326424 61.5 cm (24 in.) 6 Drawer Rolling Tool Chest & Cabinet

- 4 Drawers chest and 2 drawers and 2 door cabinet
- Ball-bearing slides
- Chest dimensions: 59.7 x 25.7 x 34.3 cm (23-1/2 x 10 x 13-1/2 in.)
- Cabinet dimensions: 61.5 x 29.5 x 70.5 cm (24 x 11-1/2 x 27-3/4 in.) with castors
- All steel construction
- 4 Casters 3 x 1 in.
- 70 kg (154 lbs.) Total capacity



Case Pack	Case Weight	Case Size	20' FCL	40' FCL
1	25 kg (55 lbs.)	67 x 35 x 66.5 cm (26-1/4 x 13-3/4 x 26 in.)	153	315



4 Drawer chest



2 Drawer mobile cabinet



Ball bearing drawer system



326428 50.8 cm (20 in.) Tool Chest & Cabinet

- 2-Drawer chest and 1-drawer and 1-door cabinet
- Chest dimensions: 45.7 W x 22.1 D x 31.5 H cm (18 x 8-5/8 x 12-3/8 in.)
- Cabinet dimensions: 50.8 W x 27 D x 68 H cm (20 x 10-5/8 x 26-3/4 in.) with castors
- All steel construction
- Ball-bearing slides
- 4 Casters 3 x 1 in.
- 70 kg (154 lbs.) Total capacity



Case Pack	Case Weight	Case Size	20' FCL	40' FCL	40' HQ
1	17 kg (37 lbs.)	53 x 29 x 60 cm (20-7/8 x 11-3/8 x 23-5/8 in.)	264	528	704



Durable steel construction



Ball bearing drawer slides



72 mm (3 in.) Castors
70 kg (154 lbs.) Total capacity





326026 66 cm (26 in.) 7-Drawer Tool Chest

- All-steel construction
- 66 W x 40.5 D x 45 H cm (26 x 16 x 17-3/4 in.)
- 0.087 Cubic meters (5,333 cubic inches) capacity
- 7 Drawers
 - 3pc - 19.3 W x 36.5 D x 5 H cm (7-1/2 x 14-3/8 x 2 in.)
 - 3pc - 58.3 W x 36.5 D x 5 H cm (23 x 14-3/8 x 2 in.)
 - 1pc - 58.3 W x 36.5 D x 8 H cm (23 x 14-3/8 x 3-1/8 in.)



Case Pack	Pallet Pack	Case Weight	Pallet Size	20' FCL	40' FCL
1	1	40.4 kg (89 lbs.)	77 x 51 x 63 cm (30-1/4 x 20 x 24-3/4 in.)	102	216



326027 68 cm (26-1/2 in.) 7-Drawer Wide Roll Away Cabinet

- All-steel construction
- 0.146 Cubic meters (8,847 cubic inches) capacity
- 68 W x 46 D x 85 H cm (26-1/2 x 18 x 32-1/2 in.) with castors
- 7 Drawers
 - 4pc - 60 W x 40.5 D x 5 H cm (23-5/8 x 16 x 2 in.)
 - 2pc - 60 W x 40.5 D x 10 H cm (23-5/8 x 16 x 4 in.)
 - 1pc - 60 W x 40.5 D x 20 H cm (23-5/8 x 16 x 8 in.)



Case Pack	Pallet Pack	Case Weight	Pallet Size	20' FCL	40' FCL
1	1	61.4 kg (135 lbs.)	78 x 54 x 89 cm (30-3/4 x 21-1/4 x 35 in.)	56	120



Gas lid lifts for easy opening of top lid



TPR corner protector (4 pc)



Heavy-duty full-extension ball-bearing drawers



Removable hardware tray



Grease-resistant EVA drawer liners keeps tools in place



10 x 2.5 cm / 4 x 1 in. Casters (4pc) provide up to 700 lbs. load rating



TOOL CHEST & CABINET

326024 66 cm (26 in.) 6-Drawer Wide Roll Away Cabinet

- All-steel construction
- 66 W x 48 D x 93 H cm (26 x 19 x 36-1/2 in.) with castors
- 0.151 Cubic meters (9,215 cubic inches) capacity
- Built-in storage compartment
- Grease-resistant EVA drawer liners keeps tools in place
- Heavy-duty full-extension ball-bearing drawers
- TPR corner protector (4 pc)
- 10 x 2.5 cm (4 x 1 in.) casters (4 pc) provide up to 700 lbs. load rating
- Locking system
- 6 Drawers
 - 3pc - 54.5 W x 42.5 D x 6 H cm (21-1/2 x 16-3/4 x 2-3/8 in.)
 - 1pc - 54.5 W x 42.5 D x 11.5 H cm (21-1/2 x 16-3/4 x 4-5/8 in.)
 - 2pc - 54.5 W x 42.5 D x 18 H cm (21-1/2 x 16-3/4 x 7 in.)



Case Pack	Pallet Pack	Case Weight	Pallet Size	20' FCL	40' FCL
1	1	54.7 kg (121 lbs.)	77 x 56 x 97 cm (30-1/4 x 22 x 38 in.)	62	124



Heavy-duty full-extension ball-bearing drawers



Grease-resistant EVA drawer liners keeps tools in place



TPR corner protector (4 pc)



10 x 2.5 cm / 4 x 1 in. casters (4 pc) provide up to 700 lbs. load rating



Flush mount push bar for easy cabinet movement

326023 66 cm (26 in.) Wide Roll Away Cabinet

- All-steel construction
- 66 W x 48 D x 93 H cm (26 x 19 x 36-1/2 in.) with castors
- 0.167 Cubic meters (10,177 cubic inches) capacity
- Built-in storage compartment
- Grease-resistant EVA drawer liners keeps tools in place
- Heavy-duty full-extension ball-bearing drawers
- TPR corner protector (4 pc)
- 10 x 2.5 cm (4 x 1 in.) casters (4 pc) provide up to 700 lbs. load rating
- Locking system
- 3 Drawers
 - 3pc - 54.5 W x 42.5 D x 13 H cm (21-1/2 x 16-3/4 x 5-1/8 in.)



Case Pack	Pallet Pack	Case Weight	Pallet Size	20' FCL	40' FCL
1	1	44.9 kg (99 lbs.)	77 x 56 x 97 cm (30-1/4 x 22 x 38 in.)	62	124





326430 65.2 cm (25-1/2 in.) 7-Drawer Tool Chest

- 65.2 W x 45.2 D x 45 H cm (25-1/2 x 17-3/4 x 17-3/4 in.)
- All steel construction
- EVA drawer liner
- Alu. Drawer trims



Case Pack	Case Weight	Case Size	20' FCL	40' FCL	40' HQ
1	35.5 kg	72 x 52 x 52 cm (28-3/8 x 20-1/2 x 20-1/2 in.)	140	292	365



326432 66.2 cm (26 in.) 7-Drawer Wide Roll-Away Cabinet

- 66.2 W x 46.2 D x 90.1 H cm (26 x 18 x 35-1/2 in.) with castors
- All steel construction
- 3 mm Rubber mat on the top
- EVA drawer liner



Case Pack	Case Weight	Case Size	20' FCL	40' FCL	40' HQ
1	49.2 kg (108 lbs.)	72 x 52 x 84 cm (28-3/8 x 20-1/2 x 33 in.)	66	132	207



Gas lid lifts for easy opening of top lid



Plastic tray with dividers on the top



Full extension ball bearing drawer slides



Metal push bar for easy cabinet movement



Plastic screwdriver holder and bin



1 in. x 4 in. castors - 2pc rotatable w/ brake, 2pc fixed

TOOL CHEST & CABINET

326434 66.2 cm (26 in.) 3-Drawer With 1-Door Wide Cabinet

- 66.2 W x 46.2 D x 90.1 H cm (26 x 18 x 35-1/2 in.) with castors
- All steel construction
- 3 mm Rubber mat on the top
- EVA drawer liner



Case Pack	Case Weight	Case Size	20' FCL	40' FCL	40' HQ
1	40 kg (88 lbs.)	72 x 52 x 84 cm (28-3/8 x 20-1/2 x 33 in.)	66	132	207



Metal push bar for easy cabinet movement | Plastic tray with dividers on the top | Plastic screwdriver holder and bin | Full extension ball bearing drawer slides | 1 in. x 4 in. castors - 2pc rotatable w/ brake, 2pc fixed



326436 66.2 cm (26 in.) 5-Drawer Wide Roll-Away Cabinet

- 66.2 W x 46.2 D x 90.1 H cm (26 x 18 x 35-1/2 in.) with castors
- All steel construction
- 3 mm Rubber mat on the top
- EVA drawer liner



Case Pack	Case Weight	Case Size	20' FCL	40' FCL	40' HQ
1	46 kg (101 lbs.)	72 x 52 x 84 cm (28-3/8 x 20-1/2 x 33 in.)	66	132	207

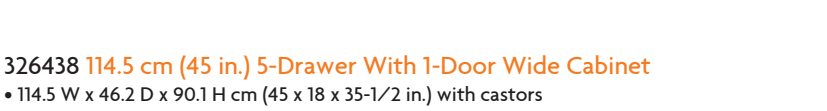

Metal push bar for easy cabinet movement | Plastic tray with dividers on the top | Plastic screwdriver holder and bin | Full extension ball bearing drawer slides | 1 in. x 4 in. castors - 2pc rotatable w/ brake, 2pc fixed



326438 114.5 cm (45 in.) 5-Drawer With 1-Door Wide Cabinet

- 114.5 W x 46.2 D x 90.1 H cm (45 x 18 x 35-1/2 in.) with castors
- All steel construction
- 3 mm Rubber mat on the top
- EVA drawer liner



Case Pack	Pallet Pack	Case Weight	Pallet Size	20' FCL	40' FCL
1	1	72.8 kg (160 lbs.)	125 x 54 x 98 cm (49-1/4 x 21-1/4 x 38-1/2 in.)	36	80



Metal push bar for easy cabinet movement | Plastic tray with dividers on the top | Plastic screwdriver holder and bin | Full extension ball bearing drawer slides | 1 in. x 4 in. castors - 2pc rotatable w/ brake, 2pc fixed



326402 68 cm (26-1/2 in.) 3-Drawer Project Center

- 68 W x 58 D x 90 H cm (26-1/2 x 23 x 35-1/2 in.) with castors
- 0.135 Cubic meters (8,219 cubic inches) capacity
- Molded work top
- Net weight: 38.9 kg (86 lbs.)
- 3 Drawers and 1 door:
 - 3pc - 57 W x 41 D x 11 H cm (22 x 16-3/8 x 4 in.)
 - 1pc - 58 W x 41 D x 27 H cm (22-3/4 x 16-3/8 x 10 in.)



Case Pack	Pallet Pack	Case Weight	Pallet Size	20' FCL	40' FCL
1	1	49.5 kg (109 lbs.)	77 x 61 x 107 cm (30-1/4 x 24 x 42 in.)	50	114



• Heavy-duty 10 x 5 cm (4 x 2 in.) castors provide up to 750 lbs. load rating | • Aluminum side handles | • Ball-bearing drawer slides | • Reinforced oversized molded work top with large MDF work surface | • Large storage cabinet





326082 78.5 cm (30-7/8 in.) Professional Service Cart

- 78.5 W x 42.7 D x 93.8 H cm (30-7/8 x 16-7/8 x 36-7/8 in.) with castors
- Heavy duty ball bearing slide drawers
- Drawer and top are keyed alike for security
- 2 Cantilever trays for more storage
- Grease resistant drawer liners
- Large easy to maneuver 10 cm (4 in.) casters; two locking and two standard

Holds up to
300 kg
(660 lbs.)
total



Case Pack	Case Weight	Case Size	20' FCL	40' FCL	40' HQ
1	40 kg (88 lbs.)	86 x 53 x 66 cm (33-7/8 x 20-7/8 x 26 in.)	84	174	232

326084 76 cm (29-7/8 in.) Deluxe Service Cart

- 76 W x 40.6 D x 92 H cm (29-7/8 x 16 x 36-1/8 in.) with castors
- Drawers and top are keyed alike for security
- Ball bearing drawer slides
- Grease resistant drawer liners
- Large easy to maneuver 10 cm (4 in.) casters; two locking and two standard

Holds up to
110 kg
(240 lbs.)
total



Case Pack	Case Weight	Case Size	20' FCL	40' FCL
1	32.7 kg (72 lbs.)	84 x 53 x 46.5 cm (33 x 21 x 18-1/4 in.)	128	236

326080 76 cm (30 in.) Bench Service Cart

- 76 W x 52.5 D x 99 H cm (30 x 20-5/8 x 39 in.) with castors
- Heavy duty ball bearing slide drawers and locking slide top
- Drawer and top are keyed alike for security
- Grease resistant rubber top mat and drawer liners
- Large easy to maneuver 10 cm (4 in.) casters; two locking and two standard
- Side trays included for additional storage

Holds up to
450 kg
(990 lbs.)
total



Case Pack	Pallet Pack	Case Weight	Pallet Size	20' FCL	40' FCL
1	4	60.2 kg (133 lbs.)	115 x 81 x 123 cm (45-1/4 x 31-7/8 x 48-1/2 in.)	112	232

TOOL CHEST & CABINET



326081 29.5 in. 2-Tier steel service cart

- 75 W x 38 D x 78.5 H cm (29-1/2 x 15 x 30-7/8 in.) with castors
- Utility cart with 2 trays
- Powder coating finish
- Alu. Brand badge

NEW

Holds up to
200 kg
(440 lbs.)
total



Case Pack	Case Weight	Case Size	20' FCL	40' FCL	40' HQ
1	13.5 kg (30 lbs.)	73 x 41 x 14 cm (28-3/4 x 16-1/2 x 5-1/2 in.)	704	1,440	1,620



Durable steel construction



2 x side pegboard



Heavy duty 2.5 in. castors with brakes



Comfort grip handles



326083 29.5 in. 2-Tier steel service cart

- 75 W x 38 D x 78.5 H cm (29-1/2 x 15 x 30-7/8 in.) with castors
- Utility cart with 2 trays
- Powder coating finish
- Alu. Brand badge

NEW

Holds up to
200 kg
(440 lbs.)
total



Case Pack	Case Weight	Case Size	20' FCL	40' FCL	40' HQ
1	16.3 kg (36 lbs.)	73 x 41 x 22 cm (28-3/4 x 16-1/2 x 8-5/8 in.)	440	900	1,080



326086 76 cm (29-7/8 in.) Multi Purpose Service Cart

- 76 W x 40.6 D x 81.3 H cm (29-7/8 x 16 x 32 in.) with castors
- Chrome steel frame
- Shelf dimensions - 76 W x 40.5 D x 7 H cm (29-7/8 x 16 x 2-3/4 in.)
- Two locking and two standard large easy to maneuver 10 cm (4 in.) casters
- Load capacity 90 kg (200 lbs.)



Case Pack	Case Weight	Case Size	20' FCL	40' FCL
1	13 kg (28.2 lbs.)	83.5 x 42.5 x 22.5 cm (83-5/8 x 16-3/4 x 8-7/8 in.)	385	770





326089 Plastic Service Cart

- 86.6 W x 44 D x 82.5 H cm (34 x 17 x 32-1/2 in.) with castors
- Extremely durable service cart constructed from plastic
- Plastic service cart is less conductive than metal one
- Ideal for use with electronic components
- Featuring 2 rigid & swivel (5 in.) rubber casters
- Assembles in minutes



Case Pack	Case Weight	Case Size	20' FCL	40' FCL
1	15.6 kg (34.4 lbs.)	90 x 47 x 24 cm (35-3/8 x 18-1/2 x 9-1/2 in.)	270	576



5 in. Casters



Extension lead storage



Integrated push bar



326087 Plastic Service Cart

- 86.6 W x 44 D x 82.5 H cm (34 x 17 x 32-1/2 in.) with castors
- Extremely durable service cart constructed from plastic
- Plastic service cart is less conductive than metal one
- Ideal for use with electronic components
- Featuring 2 rigid & swivel (5 in.) rubber casters
- Assembles in minutes



Case Pack	Case Weight	Case Size	20' FCL	40' FCL
1	16 kg (35.3 lbs.)	90 x 47 x 24 cm (35-3/8 x 18-1/2 x 9-1/2 in.)	270	576



5 in. Casters



Extension lead storage



Integrated push bar



326091 Plastic service cart with metal drawer

- 86.6 W x 44 D x 82.5 H cm (34 x 17 x 32-1/2 in.) with castors
- Extremely durable service cart constructed from plastic
- Plastic service cart is less conductive than metal one
- Ideal for use with electronic components
- Featuring 2 rigid & swivel 5" rubber casters
- Assembles in minutes
- 1x Metal drawer, 2x side trays and 1x pegboard

NEW

Holds up to
220 kg
(484 lbs.)
total



Case Pack	Case Weight	Case Size	20' FCL	40' FCL	40' HQ
1	22 kg (48 lbs.)	90 x 47 x 37 cm (35-3/8 x 18-1/2 x 14-1/2 in.)	180	384	448

TOOL CHEST & CABINET

326088 Structural Foam Mobile Work Center

- 124.7 W x 69.8 D x 99.7 H cm (49 x 27-1/2 x 39-1/4 in.) with castors
- Heavy-duty structural foam and steel construction
- 104.5 cm (41-1/8 in.) x 60.4 cm (23-3/4 in.) Work surface supports up to 227 kg (500 lbs.)
- 11 kg (25 lbs.) Rated ball bearing drawer slides
- 12.7 cm (5 in.) Non-marring casters
- Includes 2 locking swivel casters for easy mobility
- Security lock for drawer and cabinets
- Includes 3 accessory bins and 2 hooks

Holds up to
363 kg
(800 lbs.)
total



Case Pack	Case Weight	Case Size	20' FCL	40' FCL	40' HQ
1	52.9 kg (116.6 lbs.)	113 x 72 x 36 cm (44-1/2 x 28-3/8 x 14-1/8 in.)	96	198	231



Push handle with tool storage



Accessory hooks



Accessory bins



5 in. Non-marking casters



4 Power outlets with
2 USB power supplies



Central locking system



Ball-bearing drawer slides



Multi-purpose storage space

326090 Utility Cart

- 84 W x 52 D x 8 H cm (33 x 20-1/2 x 3-1/8 in.) without castor
- Can be folded
- Handle snap lock
- 3 Position folding steel handle
- 4 x Castors can be fitted into bottom

Holds up to
225 kg
(495 lbs.)
total



Case Pack	Case Weight	Case Size	20' FCL	40' FCL	40' HQ
6	54.7 kg (121 lbs.)	57 x 65 x 86 cm (22-1/2 x 25-1/2 x 33-7/8 in.)	432	864	1,296



MULTI-FUNCTION PLASTIC SERVICE CART

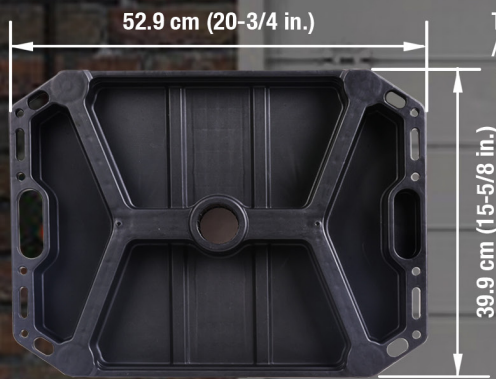

Through/blind hole for level /mop/long handle tools

Modular tray



86.9cm (34-1/8 in.)



Holds up to
15 kg
(33 lbs.)
each layer

Contents not included



326085 Three plastic trays service cart

NEW

- 52.9 W x 39.9 D x 86.9 H cm (20-3/4 x 15-5/8 x 34-1/8 in.) with castors
- Modular tray
- 2 x Removable side cups
- Tool organizer holes
- Hanger designed on the corner
- 4 x Casters 3x1 in.



Case Pack	Case Weight	Case Size	20' FCL	40' FCL	40' HQ
1	5.6 kg (12.3 lbs.)	54 x 41 x 28 cm (21-1/4 x 16-1/8 x 11 in.)	448	928	1,044

TOOL CHEST & CABINET

326062 24 in. Jobsite Box

- 61 W x 31.7 D x 38.6 H cm (24 x 12-1/2 x 15-1/8 in.)
- Tough industrial powder coating finish
- 0.074 Cubic meters (4,527 cubic inches) capacity



Case Pack	Case Weight	Case Size	20' FCL	40' FCL	40' HQ
1	34 kg (75 lbs.)	63 x 34 x 40.5 cm (24-13/16 x 13-3/8 x 15-15/16 in.)	305	635	762

326060 36 in. Jobsite Box

- 91.5 W x 47.8 D x 54.4 H cm (36 x 18-13/16 x 21-7/16 in.)
- Tough industrial powder coating finish
- 0.246 Cubic meters (15,047 cubic inches) capacity



Case Pack	Case Weight	Case Size	20' FCL	40' FCL
1	45.6 kg (101 lbs.)	94 x 50 x 57 cm (37 x 19-11/16 x 22-1/2 in.)	88	184

326061 48 in. Jobsite Box

- 122 W x 61 D x 71 H cm (48 x 24 x 28 in.)
- Tough industrial powder coating finish
- 0.528 Cubic meters (32,325 cubic inches) capacity



Case Pack	Case Weight	Case Size	20' FCL	40' FCL
1	74.5 kg (164 lbs.)	124 x 63 x 74 cm (48-13/16 x 24-13/16 x 29-1/8 in.)	39	84

326076 36 & 48 in. Combo Jobsite Box

- 91.5 W x 47.8 D x 54.4 H cm (36 x 18-13/16 x 21-7/16 in.)
- 122 W x 61 D x 71 H cm (48 x 24 x 28 in.)
- Tough industrial powder coating finish



Case Pack	Case Weight	Case Size	20' FCL	40' FCL
1	113.2 kg (250 lbs.)	124 x 63 x 74 cm (48-13/16 x 24-13/16 x 29-1/8 in.)	39	84

326077 24 & 36 in. Combo Jobsite Box

- 61 W x 31.7 D x 38.6 H cm (24 x 14-1/2 x 15-3/16 in.)
- 91.5 W x 47.8 D x 54.4 H cm (36 x 18-13/16 x 21-7/16 in.)
- Tough industrial powder coating finish



Case Pack	Case Weight	Case Size	20' FCL	40' FCL
1	74 kg (163 lbs.)	94 x 50 x 57 cm (37 x 19-11/16 x 22-1/2 in.)	88	184



Locking lid bracket



Recessed and concealed locking area protects padlock



Recessed side handle for easy transportation



Contents not included

326200 Bar Table

- 60 W x 60 D x 98 H cm (23-5/8 x 23-5/8 x 38-3/5 in.)
- Table top diameter: 60 cm (24 in.)
- Tall bar table with adjustable, non-slip feet
- Chrome-plated legs and foot rest



Tools & assortments not included



6 1942629 201649

Case Pack	Case Weight	Case Size	20' FCL	40' FCL
1	10 kg (22 lbs.)	72 x 67 x 19.5 cm (28-1/3 x 26-3/8 x 7-5/7 in.)	240	500

326201 Bar Stool

- 50 W x 50 D x 76 H cm (20 x 20 x 30 in.)
- Seat swivel 360°
- 25mm (1 in.) Cushion foam
- Chrome-plated legs and foot rest
- 136 kg (300 lbs.) Capacity



Tools & assortments not included



6 1942629 201656

Case Pack	Case Weight	Case Size	20' FCL	40' FCL	40' HQ
1	5.5 kg (12 lbs.)	67 x 51 x 13 cm (26-3/8 x 20 x 5 in.)	648	1,368	1,520

ACCESSORIES

326100 Socket Organizer Set

- A and D: 28 W x 40.5 D cm (11 x 16 in.)
- B and E: 19 W x 40.5 D cm (7-1/2 x 16 in.)
- C and F: 9 W x 40.5 D cm (3-1/2 x 16 in.)
- Six-tray set includes SAE and metric 1/4, 3/8 and 1/2 in. drive trays
- Fits Tactix™ tool cabinet drawers (326004, 326005, 326008)
- Extra storage area for ratchets and long extensions
- All trays quickly convert for deep-well sockets (riser pins included)
- Organize up to 195 pc SAE/metric sockets
- Designate holes for 6-point and 12-point sockets (not recommended for use with 8-point sockets)



Case Pack	Case Weight	Case Size	20' FCL	40' FCL
6	11 kg (24 lbs.)	37 x 32 x 50 cm (15 x 13 x 20 in.)	2,688	5,520



Tool & accessories not included



Tool & accessories not included



Tool & accessories not included

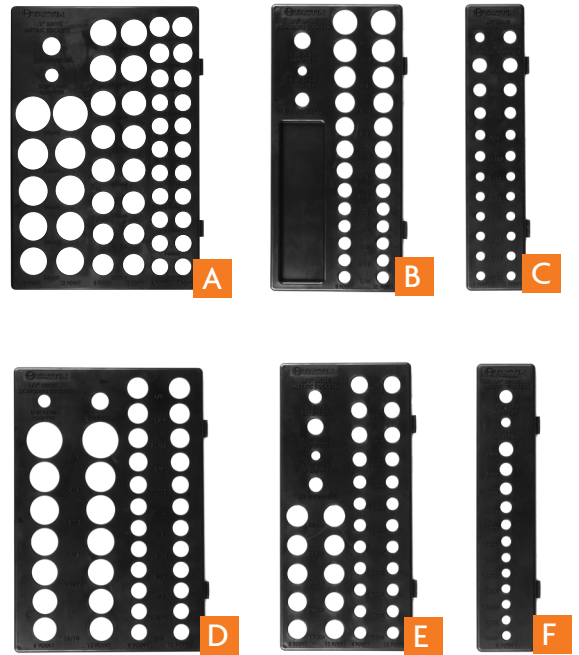

326101 Drawer Organizer

- 26 x 55 x 3.8 cm (10-1/4 x 21-5/8 x 1-1/2 in.)
- 6 Compartments to organize tools, hardware and fasteners
- Solvent and UV resistant
- Durable plastic construction
- Fits Tactix™ tool cabinet drawers (326001, 326002, 326004, 326005)



Inner Pack	Case Pack	Case Weight	Case Size	20' FCL	40' FCL
6	24	9 kg (19 lbs.)	57 x 57 x 26 cm (23 x 23 x 10 in.)	8,640	18,144



326102 Drawer Organizer

- 26 x 55 x 3.8 cm (10-1/4 x 21-5/8 x 1-1/2 in.)
- 11 Compartments to organize tools, hardware and fasteners
- Solvent and UV resistant
- Durable plastic construction
- Fits Tactix™ tool cabinet drawers (326001, 326002, 326004, 326005)



Inner Pack	Case Pack	Case Weight	Case Size	20' FCL	40' FCL
6	24	10 kg (22 lbs.)	57 x 57 x 26 cm (23 x 23 x 10 in.)	8,640	18,144



326103 3-PC Drawer Organizer Set

- A, B and C: 18 x 40 x 6 cm (7 x 15-3/4 x 2-3/8 in.)
- Ideal for tools, parts and fasteners
- Solvent and UV resistant
- Durable plastic construction
- Fits Tactix™ tool cabinet drawers (326004, 326005, 326008)



Tool & accessories not included



Case Pack	Case Weight	Case Size	20' FCL	40' FCL
6	4.3 kg (9.5 lbs.)	40 x 34 x 43 cm (15-3/4 x 13-1/4 x 16-7/8 in.)	2,880	6,000

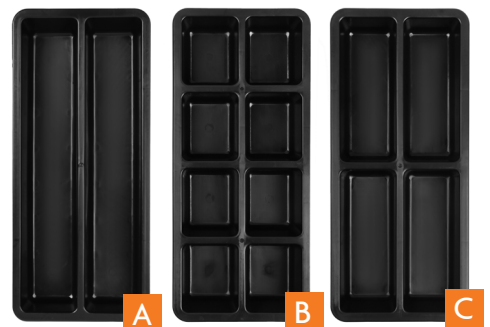



- A** 326250 - 2-Door Tall Cabinet
- B** 326251 - 5-Drawer Rolling Cabinet
- C** 326252 - 1-Door Cabinet
- D** 326253 - Work Bench
- E** 326254 - 2-Door Wall Cabinet
- F** 326255 - 2 PC Pegboard Set

GARAGE STORAGE SYSTEM

326250 169 cm (66 in.) 2-Door Tall Locker Cabinet

- 67.5 W x 40.5 D x 169 H cm (26-1/2 x 16 x 66 in.)
- All-steel construction
- Adjustable shelves (3 pieces)
- Easy to assemble
- Aluminum recessed door handles



Case Pack	Pallet Pack	Case Weight	Pallet Size	20' FCL	40' FCL
1	6	40.4 kg (89 lbs.)	173 x 50 x 115 cm (68-1/2 x 19-1/2 x 45-1/4 in.)	168	360



Heavy-duty levelers



326251 67.5 cm (26-1/2 in.) 5-Drawer Rolling Cabinet

- 67.5 W x 45 D x 83.2 H cm (26-1/2 x 17-5/8 x 32-3/4 in.)
- All-steel construction
- Full-extension ball-bearing slide drawers
- 5 Drawers
- 1pc - 56.5 W x 43.5 D x 5.1 H cm (22-1/4 x 17-1/8 x 2 in.)
- 2pc - 56.5 W x 43.5 D x 10.5 H cm (22-1/4 x 17-1/8 x 4-1/8 in.)
- 2pc - 56.5 W x 43.5 D x 16.2 H cm (22-1/4 x 17-1/8 x 6-3/8 in.)



Case Pack	Pallet Pack	Case Weight	Pallet Size	20' FCL	40' FCL
1	1	47.8 kg (105.4 lbs.)	79 x 54 x 87 cm (31 x 21-1/4 x 34-1/4 in.)	56	120



Heavy-duty 10 x 5 cm (4 x 2 in.) casters provide up to 750 lbs. load rating



Grease-resistant EVA drawer liners

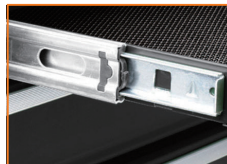

Heavy-duty full-extension ball-bearing drawers



326252 40.5 cm (16 in.) 1-Door Cabinet

- 40.5 W x 41.5 D x 82.5 H cm (15-7/8 x 16-1/4 x 32-1/2 in.)
- All-steel construction
- Aluminum recessed door handles
- Easy to assemble



Case Pack	Pallet Pack	Case Weight	Pallet Size	20' FCL	40' FCL
1	12	14 kg (31 lbs.)	85 x 88 x 100 cm (33-1/2 x 34-1/2 x 39-3/8 in.)	288	672



Heavy-duty levelers



326253 162.5 cm (64 in.) Wood Bench
 • 162.5 W x 51 D x 95.5 H cm (64 x 20 x 37-1/2 in.)



Case Pack	Pallet Pack	Case Weight	Pallet Size	20' FCL	40' FCL
1	7	27.5 kg (61 lbs.)	181 x 56 x 108 cm (71-1/4 x 22 x 42-1/2 in.)	168	350

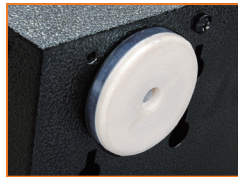

Heavy-duty levelers



326254 67.5 cm (26-1/2 in.) 2-Door Wall Cabinet

- 67.5 W x 30.5 D x 61 H cm (26-1/2 x 12 x 24 in.)
- All-steel construction
- Easy to assemble
- Aluminum recessed door handles



Case Pack	Pallet Pack	Case Weight	Pallet Size	20' FCL	40' FCL
1	10	17.4 kg (38 lbs.)	73 x 77 x 106 cm (28-3/4 x 30-1/4 x 41-3/4 in.)	480	960

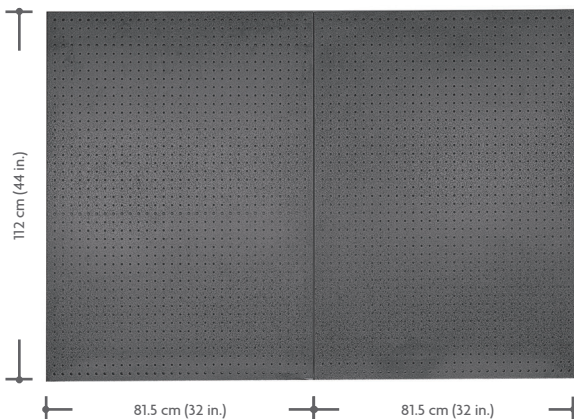

326255 2 PC Pegboard Set

- 81.5 W x 112 D cm (32 x 44 in.) each pegboard
- All-steel construction
- Easy to assemble



Case Pack	Pallet Pack	Case Weight	Pallet Size	20' FCL	40' FCL
1	12	12.7 kg (28 lbs.)	118 x 88 x 102 cm (46-1/2 x 34-5/8 x 40-1/8 in.)	240	552

GARAGE STORAGE SYSTEM



- | | |
|--|-------------------------------------|
| A 326231 - 2-Door Tall Locker Cabinet | E 326235 - Center Drawer |
| B 326232 - 2-Door Cabinet | F 326237 - Pegboard Set |
| C 326233 - 5-Drawer Cabinet | G 326039 - Long Wood Worktop |
| D 326234 - 2-Door Wall Cabinet | |



326231 184.5cm (72-1/2 in.) 2-Door Tall Locked Cabinet

- 75.7 W x 45.5 D x 184.5 H cm (29-7/8 x 18 x 72-1/2 in.)
- All-steel construction
- Adjustable shelves (2 pieces)
- Easy to assemble
- Aluminum recessed door handles



Case Pack	Pallet Pack	Case Weight	Pallet Size	20' FCL	40' FCL
1	5	60.5 kg (133 lbs.)	188 x 83 x 73 cm (74 x 32-1/2 x 28-3/4 in.)	60	140



Heavy-duty levelers



Solid wood worktop (sold separately - 326038)

326232 76.3 cm (30 in.) 2-Door Cabinet

- 76.3 W x 45.5 D x 93 H cm (30 x 18 x 36-1/2 in.)
- All-steel construction
- Easy to assemble
- Aluminum recessed door handles
- Solid wood worktop (sold separately - 326038)
- Drawer shelf (sold separately - 326246)



Case Pack	Pallet Pack	Case Weight	Pallet Size	20' FCL	40' FCL
1	7	34.2 kg (75.4 lbs.)	98 x 82 x 115 cm (38-1/2 x 32-1/4 x 45-1/4 in.)	196	392



Heavy-duty levelers



Solid wood worktop (sold separately - 326038)

326233 76 cm (30 in.) 5-Drawer Cabinet

- 76 W x 45 D x 93 H (30 x 18 x 36-1/2 in.)
- All-steel construction
- 5 Drawers
- 1pc - 66 W x 40 H x 8 D cm (26 x 15-3/4 x 3-1/4 in.)
- 3pc - 66 W x 40 H x 16.5 D cm (26 x 15-3/4 x 6-1/2 in.)
- 1pc - 66 W x 40 H x 26.5 D cm (26 x 15-3/4 x 10-1/2 in.)



Case Pack	Pallet Pack	Case Weight	Pallet Size	20' FCL	40' FCL
1	1	61.2 kg (135 lbs.)	86 x 53 x 108.5 cm (33-3/4 x 20-3/4 x 42-3/4 in.)	48	104



Heavy-duty levelers



Grease-resistant EVA drawer liners



Heavy-duty full-extension ball-bearing drawers

326234 68 cm (27 in.) 2-Door Wall Cabinet

- 68 W x 35 D x 72 H cm (26-3/4 x 13-3/4 x 28-1/4 in.)
- All-steel construction
- Adjustable shelves
- Easy to assemble
- Aluminum recessed door handles



Case Pack	Pallet Pack	Case Weight	Pallet Size	20' FCL	40' FCL
1	6	27 kg (60 lbs.)	77 x 73 x 79 cm (30-1/4 x 28-3/4 x 31 in.)	252	540



326235 Center Drawer

- 61 W x 46 D x 14 H cm (24 x 18 x 5-1/2 in.)
- All-steel construction
- Ball-bearing slide drawers



Case Pack	Pallet Pack	Case Weight	Pallet Size	20' FCL	40' FCL
1	10	10.8 kg (24 lbs.)	105 x 66 x 115 cm (41-1/4 x 26 x 45-1/4 in.)	320	720



326246 Drawer Shelf

- 76 W x 42 D x 11.5 H cm (30 x 16-1/2 x 4-1/2 in.)
- Easy to assemble
- Ball-bearing slide drawers
- Fits 326232



Case Pack	Pallet Pack	Case Weight	Pallet Size	20' FCL	40' FCL
1	12	10.2 kg (22 lbs.)	81 x 92 x 109 cm (31-3/4 x 36-1/4 x 43 in.)	392	840



326237 3-PC Pegboard Set

- 71 W x 112 H cm (28 x 44 in.) each pegboard
- All-steel construction



Case Pack	Pallet Pack	Case Weight	Pallet Size	20' FCL	40' FCL
1	9	25.7 kg (57 lbs.)	115 x 75 x 112 cm (45-1/4 x 29-1/2 x 44 in.)	270	540

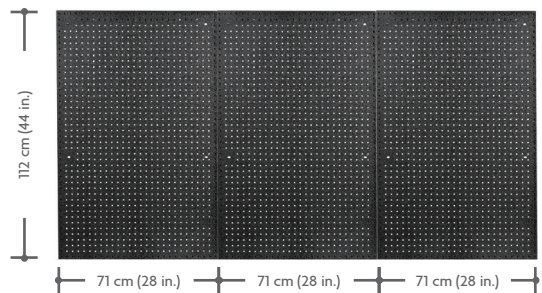

326038 76 cm (30 in.) Wood Worktop

- 76 W x 51 D x 2.6 H cm (29-7/8 x 20 x 1 in.)
- Fits 326232 and 326233



Case Pack	Pallet Pack	Case Weight	Pallet Size	20' FCL	40' FCL
1	40	8.7 kg (19 lbs.)	96 x 110 x 113 cm (37-3/4 x 43-1/4 x 44-1/2 in.)	864	1,728



326039 213 cm (84 in.) Long Wood Worktop

- 213 W x 51 D x 2.5 H cm (84 x 20 x 1 in.)



Case Pack	Pallet Pack	Case Weight	Pallet Size	20' FCL	40' FCL
1	12	23.6 kg (52 lbs.)	233 x 55 x 79 cm (91-3/4 x 21-1/2 x 31 in.)	432	864





A 326261 - 76 cm (30 in.) 3-Drawer Roll Away Tool Cabinet

B 326262 - 114 cm (44-3/4 in.) 3-Drawer and 1-Door Workbench

C 326263 - 120 cm (47 in.) 4-Drawer Roller Cabinet

D 326264 - 76 cm (30 in.) Steel Service Cart

E 326265 - 114 cm (44-3/4 in.) 2-Door Wall Cabinet

F 326115 - 3 PC Pegboard Set

GARAGE STORAGE SYSTEM

326261 76 cm (30 in.) 3-Drawer Roll Away Tool Cabinet **NEW**

- 76 W x 46 D x 63.5 H cm (30 x 18 x 25 in.) with castors
- All steel construction
- Ball bearing slide drawer
- EVA drawer liner
- Sponge covered steel handle
- 4 in. x 1 in. Castors: 2pc rotatable w/ brake, 2pc fixed



Case Pack	Case Weight	Case Size	20' FCL	40' FCL
1	35 kg (77 lbs.)	86 x 54 x 54 cm (33-7/8 x 21-1/4 x 21-1/4 in.)	108	228



326262 114 cm (44-3/4 in.) 3-Drawer and 1-Door Workbench **NEW**

- 114 W x 60 D x 87 H cm (44-3/4 x 23-1/2 x 34-1/4 in.)
- All steel construction with wood top
- Adjustable levelers
- 3pc Drawers - 45 W x 45 D x 13 H cm (17-3/4 x 17-3/4 x 5-1/8 in.)
- One lock with two keys



Case Pack	Pallet Pack	Case Weight	Pallet Size	20' FCL	40' FCL
1	1	47 kg (103 lbs.)	124 x 116 x 95.5 cm (48-3/4 x 45-5/8 x 37-1/2 in.)	96	216



326263 120 cm (47 in.) 4-Drawer Roller Cabinet **NEW**

- 120 W x 46 D x 93.3 H cm (47 x 18 x 36-3/4 in.) with castors
- All steel construction
- 4pc 4 x 1 in. Castors
- Ball bearing slide drawer
- EVA drawer liner
- 3 mm Rubber mat on the top
- Steel Push Bar for easy movement



Case Pack	Pallet Pack	Case Weight	Pallet Size	20' FCL	40' FCL	40' HQ
1	1	69 kg (152 lbs.)	131 x 56 x 86 cm (51-1/2 x 22 x 33-7/8 in.)	34	72	108



326264 76 cm (30 in.) Steel Service Cart **NEW**

- 76 W x 41.5 D x 88.5 H cm (30 x 16-1/4 x 35 in.) with castors
- All steel construction
- 4 in. x 1 in. Swivel casters, 2 with brake
- Ball-bearing slide drawer
- EVA drawer liner



Case Pack	Case Weight	Pallet Size	20' FCL	40' FCL
1	19.5 kg (42.9 lbs.)	80 x 45.5 x 16.5 cm (31-1/2 x 17-7/8 x 6-1/2 in.)	96	216





326265 114 cm (44-3/4 in.) 2-Door Wall Cabinet

NEW

- 114 W x 30.3 D x 60.5 H cm (44-3/4 x 12 x 23-3/4 in.)
- All steel construction
- Includes: 5 pc hooks
- 6pc Small plastic trays and 4 pc big plastic trays



Case Pack	Case Weight	Case Size	20' FCL	40' FCL
1	24 kg (52.8 lbs.)	122 x 65 x 9.5 cm (48 x 25-1/2 x 3-3/4 in.)	312	672



326115 3 PC Pegboard Set

- 38 W x 1.6 D x 59.6 H cm (15 x 5/8 x 23-1/2 in.) each pegboard
- All steel construction
- Easy to assemble

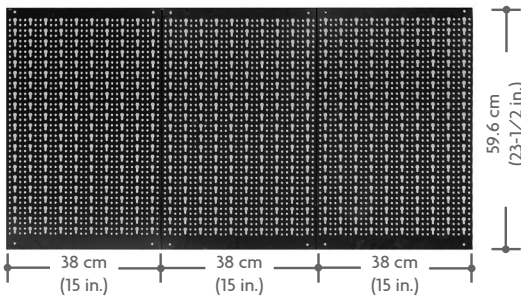

Case Pack	Pallet Pack	Case Weight	Pallet Size	20' FCL	40' FCL
1	26	5 kg (11 lbs.)	63 x 83.5 x 104 cm (24-3/4 x 33 x 41 in.)	1,300	2,704

Below accessories fit TACTIX™ part number 326115 (see page 126)

Item No.	Dimension	Function
326126	5 x 30 mm	For scissors, washers, keys, hone, tape roll, etc...
326127	5 x 50 mm	
326128	5 x 60 mm	



Item No.	Dimension	Function
326135	10 x 75 x 125 mm	Holder for different wrenches, ring, etc...



Item No.	Dimension	Function
326129	5 x 30 mm	For scissors, washers, keys, hone, tape roll, etc...
326130	5 x 50 mm	
326131	5 x 60 mm	



Item No.	Dimension	Function
326136	ø 5 x 13 mm	For various screwdrivers, hone, etc...
326137	ø 5 x 18 mm	
326138	ø 5 x 23 mm	



Item No.	Dimension	Function
326132	4 x 75 x 11 mm	For scissors, F-clamp, various saws, etc...



Item No.	Dimension	Function
326139	10 x 125 x 55 mm	For nails, nuts, unscrew, riveting, tick, washers, etc...



Item No.	Dimension	Function
326133	4 x 50 x 35 mm	For various hammers, etc...

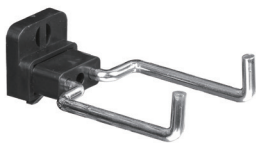

Item No.	Dimension	Function
326140	10 x 125 x 55 mm	For drills, tappers, wood spade, bits holder, etc...

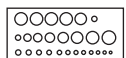

Item No.	Dimension	Function
326134	4 x 35 x 35 mm	For various pliers, shear, etc...



Item No.	Dimension	Function
326141	10 x 125 x 55 mm	For drills, tappers, wood spade, bits holder, etc...

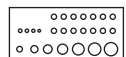
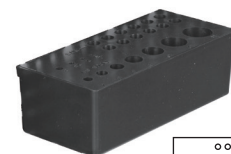

FLEX

STORAGE SYSTEM



- A** 326270 - 65.6 cm (26 in.) 1-Drawer Tool Chest
- B** 326271 - 65.6 cm (26 in.) 2-Drawer Tool Chest
- C** 326272 - 65.6 cm (26 in.) 1-Door Lift Up Tool Chest
- D** 326273 - 65.6 cm (26 in.) 2-Door Tool Cabinet
- E** 326274 - 65.6 cm (26 in.) 2-Drawer and 2-Door Tool Cabinet
- F** 326275 - Roller Base
- G** 326276 - 132 cm (52 in.) Wood Bench



326280 4PC Flex Storage set

- Steel construction with heavy-duty plastic top & bottom
- Grease-resistant EVA drawer liners keeps tools in place
- Aluminum drawer and door trim
- Can be interlocked with any other flex chest & cabinet to create a storage solution for any need
- Key lock for security and transportation



Case Pack	Case Weight	Pallet Size	20' FCL	40' FCL
1	62 kg (136.7 lbs.)	92 x 71 x 109.5 cm (36-1/4 x 28 x 43 in.)	40	84

- A** 326271 65.6 cm (26 in.) 2-Drawer Tool Chest
- B** 326272 65.6 cm (26 in.) 1-Door Lift Up Tool Chest
- C** 326274 65.6 cm (26 in.) 2-Drawer and 2-Door Tool Cabinet
- D** 326275 Roller Base



326271 65.6 cm (26 in.) 2-Drawer Tool Chest

- 65.6 W x 40 D x 37.9 H cm (26 x 15-3/4 x 15 in.)
- Steel construction with heavy-duty plastic top & bottom
- Full extension ball bearing drawer slides
- Grease-resistant EVA drawer liners keeps tools in place
- Aluminum drawer trim
- Ideal for storage of tools and accessories
- Can be interlocked with any other flex chest & cabinet to create a storage solution for any need
- Key lock for security and transportation



Case Pack	Case Weight	Case Size	20' FCL	40' FCL
1	20.5 kg (45.2 lbs.)	70 x 45 x 43.5 cm (27-1/2 x 17-3/4 x 17-1/8 in.)	210	432



Steel drawer construction



Ball bearing slides 44 lbs. (20 kg) load capacity per drawer



Key lock for security and transportation



Can be used with all Tactix Flex™ storage system components

GARAGE STORAGE SYSTEM

326272 65.6 cm (26 in.) 1-Door Lift Up Tool Chest

- 65.6 W x 40 D x 37.9 H cm (26 x 15-3/4 x 15 in.)
- Steel construction with heavy-duty plastic top & bottom
- Two air spring door lifts
- Aluminum door trim
- Ideal for storage of large items
- Can be interlocked with any other flex chest & cabinet to create a storage solution for any need
- Key lock for security and transportation



Case Pack	Case Weight	Case Size	20' FCL	40' FCL
1	11.5 kg (25.4 lbs.)	70 x 45 x 43.5 cm (27-1/2 x 17-3/4 x 17-1/8 in.)	210	432



Steel constructed rear structure with wall mounting features | Ideal for storage of large items | Key lock for security and transportation | Can be used with all Tactix Flex™ storage system components

326274 65.6 cm (26 in.) 2-Drawer and 2-Door Tool Cabinet

- 65.6 W x 40 D x 72.6 H cm (26 x 15-3/4 x 28-1/2 in.)
- Steel construction with heavy-duty plastic top & bottom
- Full extension ball bearing drawer slides
- 5pc Metal hooks included
- Grease-resistant EVA drawer liners keeps tools in place
- Aluminum drawer and door trim
- Ideal for storage of large items and tools & accessories
- Can be interlocked with any other flex chest & cabinet to create a storage solution for any need
- Key lock for security and transportation



Case Pack	Case Weight	Case Size	20' FCL	40' FCL
1	27 kg (59.5 lbs.)	70 x 45 x 77.5 cm (27-1/2 x 17-3/4 x 30-1/2 in.)	100	216



Internal accessory peg board panel | Ball bearing slides | Key lock for security and transportation | Can be used with all Tactix Flex™ storage system components

326275 Roller Base

- 71.8 W x 46.1 D x 18 H cm (28-1/4 x 18-1/8 x 7 in.) with castors
- 4pc 1 x 4" Castors; 2pc rotatable w/ brake, 2pc fixed
- Loading capacity: 300KG
- Wheels allow for easy mobility of flex chest & cabinet



Case Pack	Case Weight	Case Size	20' FCL	40' FCL
1	6.5 kg (14.3 lbs.)	77 x 50 x 14 cm (30-1/4 x 19-5/8 x 5-1/2 in.)	576	1,152



165 lbs. (75 kg) load capacity per castor | Can be used with all Tactix Flex™ storage system components



326270 65.6 cm (26 in.) 1-Drawer Tool Chest

- 65.6 W x 40 D x 37.9 H cm (26 x 15-3/4 x 15 in.)
- Steel construction with heavy-duty plastic top & bottom
- Full extension ball bearing drawer slides
- Grease-resistant EVA drawer liners keeps tools in place
- Aluminum drawer trim
- Ideal for storage of tools and accessories
- Can be interlocked with any other flex chest & cabinet to create a storage solution for any need
- Key lock for security and transportation



Case Pack	Case Weight	Case Size	20' FCL	40' FCL
1	16.5 kg (36.4 lbs.)	70 x 45 x 43.5 cm (27-1/2 x 17-3/4 x 17-1/8 in.)	210	432



- Ideal for storage of tools and accessories. (*Tools not included)
- Ball bearing slides
- Key lock for security and transportation
- Can be used with all Tactix Flex™ storage system components



326273 65.6 cm (26 in.) 2-Door Tool Cabinet

- 65.6 W x 40 D x 72.6 H cm (26 x 15-3/4 x 28-1/2 in.)
- Steel construction with heavy-duty plastic top & bottom
- 5pc Metal hooks included
- Aluminum door trim
- Ideal for storage of large items
- Can be interlocked with any other flex chest & cabinet to create a storage solution for any need
- Key lock for security and transportation



Case Pack	Case Weight	Case Size	20' FCL	40' FCL
1	23 kg (50.7 lbs.)	70 x 45 x 77.5 cm (27-1/2 x 17-3/4 x 30-1/2 in.)	100	216



- Internal accessory peg board panel
- Key lock for security and transportation
- Can be used with all Tactix Flex™ storage system components
- Adjustable steel shelf



326276 132 cm (52 in.) Work Bench

- 132 W x 46.5 D x 91.5 H cm (52 x 18 x 36 in.)
- Work surface: clear finished plywood 25mm thickness
- Use 1.2mm steel material for legs
- leveling legs for uneven floors



Case Pack	Case Weight	Case Size	20' FCL	40' FCL
1	20.4 kg (45 lbs.)	137 x 52 x 13 cm (54 x 20-1/2 x 5-1/8 in.)	180	420



Heavy-duty levelers

GARAGE STORAGE SYSTEM



- | | |
|--|--|
| A 326281 - 60 cm (23-1/2 in.) Single Drawer Cabinet | F 326286 - 60 cm (23-1/2 in.) Lift-up Door Cabinet |
| B 326282 - 60 cm (23-1/2 in.) Double Drawer Cabinet | G 326287 - 66 cm (26 in.) Overhead Lift-up Door Cabinet |
| C 326283 - 60 cm (23-1/2 in.) Triple Drawer Cabinet | H 326288 - 67cm (26-3/8 in.) Tall Locker Cabinet |
| D 326284 - 4 Pack Caster Set | I 326289 - 132 cm (52 in.) Work Bench |
| E 326285 - 60 cm (23-1/2 in.) Locker Cabinet | J 326290 - 4 Pack Pegboard Set |

326281 60 cm (23-1/2 in.) Single Drawer Cabinet

- 60 W x 51 D x 37 H cm (with foot pad 38.3 H cm)
- Steel construction
- Full extension ball bearing drawer slides - Auto-retention function
- Stainless steel corner / drawer trim / handle
- Adjustable leveling feet interlock multiple cabinets

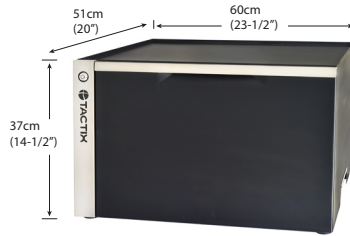

Case Pack	Case Weight	Case Size	20' FCL	40' FCL
1	23.6 kg (52 lbs.)	66 x 57 x 44 cm (26 x 22-1/2 x 17-1/4 in.)	160	360

326282 60 cm (23-1/2 in.) Double Drawer Cabinet

- 60 W x 51 D x 37 H cm (with foot pad 38.3 H cm)
- Steel construction
- Full extension ball bearing drawer slides - Auto-retention function
- Stainless steel corner / drawer trim / handle
- Adjustable leveling feet interlock multiple cabinets

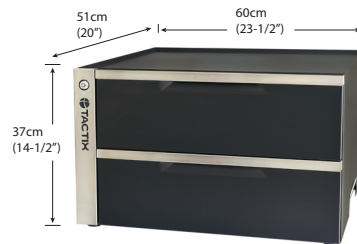

Case Pack	Case Weight	Case Size	20' FCL	40' FCL
1	25.3 kg (56 lbs.)	66 x 57 x 44 cm (26 x 22-1/2 x 17-1/4 in.)	160	360

326283 60 cm (23-1/2 in.) Triple Drawer Cabinet

- 60 W x 51 D x 37 H cm (with foot pad 38.3 H cm)
- Steel construction
- Full extension ball bearing drawer slides - Auto-retention function
- Stainless steel corner / drawer trim / handle
- Adjustable leveling feet interlock multiple cabinets

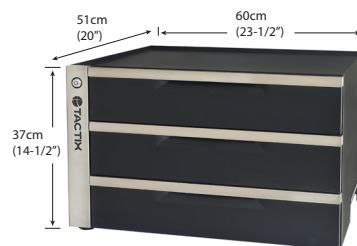

Case Pack	Case Weight	Case Size	20' FCL	40' FCL
1	27.8 kg (61 lbs.)	66 x 57 x 44 cm (26 x 22-1/2 x 17-1/4 in.)	160	360

GARAGE STORAGE SYSTEM

326285 60 cm (23-1/2 in.) Locker Cabinet

- 60 W x 51 D x 37 H cm (with foot pad 38.3 H cm)
- Steel construction
- Magnetic door catch
- With peg board on the back of the door
- Stainless steel corner / droor trim / handle
- Adjustable leveling feet interlock multiple cabinets

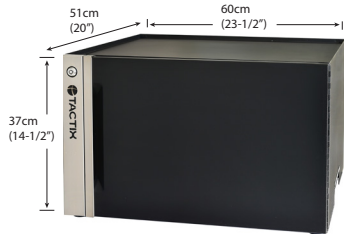

Case Pack	Case Weight	Case Size	20' FCL	40' FCL
1	16.02 kg (35 lbs.)	66 x 57 x 44 cm (26 x 22-1/2 x 17-1/4 in.)	160	360

326286 60 cm (23-1/2 in.) Lift-Up Door Cabinet

- 60 W x 51 D x 37 H cm (with foot pad 38.3 H cm)
- Steel construction (0.8 mm frame / 0.8 mm drawer thickness)
- Two gas strut door lifts
- Stainless steel corner / drawer trim / handle
- 4 x Adjustable leveling feet interlock multiple cabinets

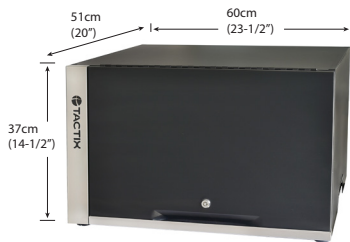

Case Pack	Case Weight	Case Size	20' FCL	40' FCL
1	16.6 kg (36.5 lbs.)	66 x 57 x 44 cm (26 x 22-1/2 x 17-1/4 in.)	160	360

326287 66 cm (26 in.) Overhead Lift-Up Door Cabinet

- 66 W x 37 D x 37 H cm (26 x 14-1/2 x 14-1/2 in.)
- Steel construction
- Two gas strut door lifts
- Stainless steel corner / droor trim

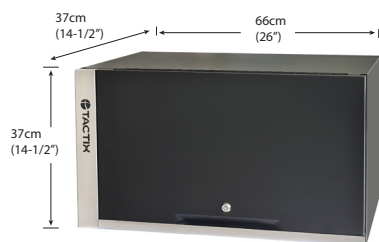

Case Pack	Case Weight	Case Size	20' FCL	40' FCL
1	12.5 kg (28 lbs.)	71 x 42.5 x 44 cm (28 x 16-3/4 x 17-1/4 in.)	215	445



326288 186.2 cm (73 in.) Tall Locker Cabinet

- 67 W x 51 D x 186.2 H cm (26-3/8 x 20 x 73 in.)
- Steel construction
- Magnetic door catch
- Four Adjustable shelves
- Stainless steel corner / door trim
- Adjustable leveling feet

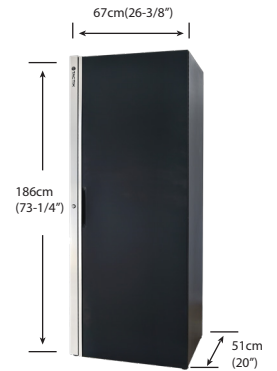

Case Pack	Case Weight	Case Size	20' FCL	40' FCL
1	68.7 kg (151 lbs.)	191 x 72 x 18 cm (75 x 21-1/2 x 7 in.)	117	234



326284 4 Pack Caster Set

- 12.7 W x 5.1 D cm (5 x 2 in.)
- Swivel casters, 2 with brake
- Loading capacity: 120 kg /pc



Case Pack	Case Weight	Case Size	20' FCL	40' FCL
4	17.92 kg (39 lbs.)	46 x 43.5 x 24 cm (18 x 17 x 9-1/2 in.)	2,460	4,980



326289 132 cm (52 in.) Work Bench

- 132 W x 51 D x 93.5 H cm (52 x 20 x 36-5/8 in.)
- Steel construction
- Stainless steel covered particle board worktop
- Adjustable leveling feet



Case Pack	Case Weight	Case Size	20' FCL	40' FCL	40' HQ
1	34 kg (75 lbs.)	136 x 55 x 15 cm (53-1/2 x 21-1/2 x 6 in.)	272	578	646

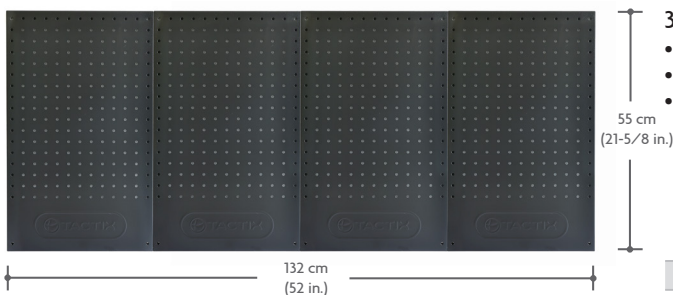

326290 4 Pack Pegboard Set

- 55 W x 33 D x 1.8 H cm (21-5/8 x 13 x 5/8 in.) each
- Steel construction
- Mounting hardware included: 16 x M5 tap screw & anchors



Case Pack	Case Weight	Case Size	20' FCL	40' FCL
1	6.6 kg (15 lbs.)	58.5 x 37.5 x 9 cm (23 x 14-3/4 x 3-1/2 in.)	1,700	3,500

STORAGE HOOK SYSTEM



Work with Tactix Rails.

Tool & accessories not included

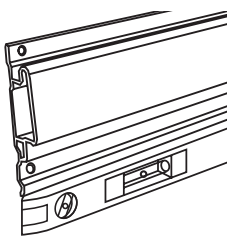

1

Leveling the rail

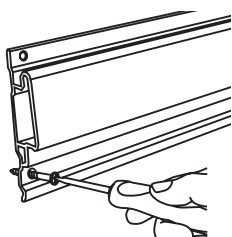

2

Hang the rail

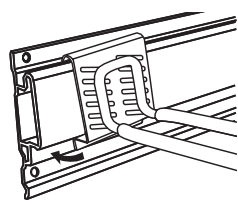

3

Attach the hooks

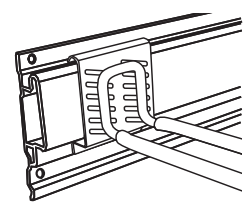

4

Store your items

328100 61 cm (24 in.) Rail

- All steel construction
- Quick and easy to install
- Great for organizing your garage!
- Holds up to 110 kg (243 lbs.)



6 970834 672466



Case Pack	Case Weight	Case Size	20' FCL
10	7.1 kg (15.6 lbs.)	68 x 11.5 x 20.8 cm (26-3/4 x 4-1/2 x 8-1/8 in.)	18,590



328102 Power Tool Hook

- Power tools
- Footballs or basketballs
- Hold up to 20 kg (44 lbs.)



Inner Pack	Case Pack	Case Weight	Case Size	20' FCL
10	40	17.4 kg (38.3 lbs.)	70 x 43 x 21 cm (27-1/2 x 17 x 8-1/4 in.)	18,920



Tool & accessories not included



328104 Large J Hook

- Electrical cords
- Hose
- Bicycle
- Holds up to 25 kg (55 lbs.)



Inner Pack	Case Pack	Case Weight	Case Size	20' FCL
10	30	13.6 kg (30 lbs.)	52 x 33 x 30 cm (20-3/8 x 13 x 11-3/4 in.)	16,380



Tool & accessories not included



328106 Double Hook

- Shovels
- Rakes
- Holds up to 20 kg (44 lbs.)



Inner Pack	Case Pack	Case Weight	Case Size	20' FCL
10	40	14.6 kg (32 lbs.)	67 x 33.6 x 22 cm (26-3/8 x 13-1/8 x 8-1/2 in.)	20,400



Tool & accessories not included

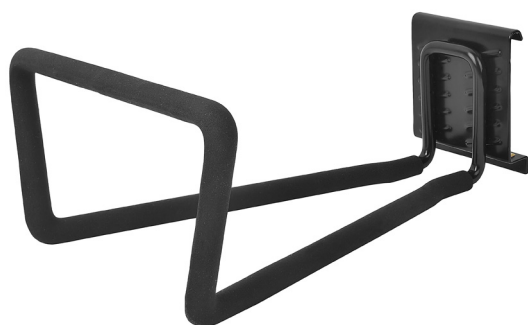

328108 Large Loop Hook

- Hose
- Footballs or basketballs
- Holds up to 20 kg (44 lbs.)



Inner Pack	Case Pack	Case Weight	Case Size	20' FCL
10	20	11.8 kg (25.6 lbs.)	53 x 29 x 22 cm (20-3/4 x 11-1/2 x 8-1/2 in.)	16,840



Tool & accessories not included

STORAGE HOOK SYSTEM

328110 Sport Equipment Hook

- Sport equipment
- Long handle tools
- Holds up to 20 kg (44 lbs.)



Tool & accessories not included



Inner Pack	Case Pack	Case Weight	Case Size	20' FCL
10	40	14.5 kg (32 lbs.)	47 x 31 x 23 cm (18-1/2 x 12 x 9 in.)	33,960



328112 Closed Hook

- Ladders
- Saw horses
- Holds up to 20 kg (44 lbs.)



Tool & accessories not included



Inner Pack	Case Pack	Case Weight	Case Size	20' FCL
10	40	16.2 kg (35.6 lbs.)	57 x 34 x 24 cm (22-1/2 x 13-1/4 x 9-1/2 in.)	24,560



328114 Double S hook

- Long handle tools
- Brooms
- Holds up to 25 kg (55 lbs.)



Tool & accessories not included



Inner Pack	Case Pack	Case Weight	Case Size	20' FCL
10	30	18.1 kg (40 lbs.)	67.5 x 31 x 18.2 cm (26-1/2 x 12-1/8 x 7-1/8 in.)	23,790



328116 Single Hook

- Bags
- Cleaning supplies
- Holds up to 15 kg (33 lbs.)



Tool & accessories not included



Inner Pack	Case Pack	Case Weight	Case Size	20' FCL
10	50	7.5 kg (16.5 lbs.)	28.5 x 22.6 x 35.5 cm (11-1/8 x 8-7/8 x 13-7/8 in.)	60,600





328118 J Hook

- Sports caps
- Cleaning supplies
- Holds up to 20 kg (44 lbs.)



6 970834 672558



Tool & accessories not included

Inner Pack	Case Pack	Case Weight	Case Size	20' FCL
10	100	11 kg (28 lbs.)	36 x 23.6 x 31.5 cm (14-1/8 x 9-1/4 x 12-3/8 in.)	106,400



328120 S Hook

- Long handle tools
- Brooms
- Holds up to 30 kg (66 lbs.)



6 970834 672565



Tool & accessories not included

Inner Pack	Case Pack	Case Weight	Case Size	20' FCL
10	40	9.8 kg (21.5 lbs.)	30 x 23 x 20.2 cm (11-3/4 x 9 x 7-7/8 in.)	85,360



328122 Dual Utility Hook

- Long handle tools
- Hose
- Holds up to 20 kg (44 lbs.)



6 970834 672572



Tool & accessories not included

Inner Pack	Case Pack	Case Weight	Case Size	20' FCL
10	30	16 kg (35.2 lbs.)	61.5 x 30 x 28 cm (24-1/8 x 4-3/4 x 11 in.)	15,840



328124 4-Way Hook

- Tools
- Cleaning supplies
- Holds up to 30 kg (66 lbs.)



6 970834 672589



Tool & accessories not included

Inner Pack	Case Pack	Case Weight	Case Size	20' FCL
10	30	13.6 kg (30 lbs.)	50.5 x 32 x 37.5 cm (19-7/8 x 12-1/2 x 14-3/4 in.)	14,400



328126 Storage Basket

- Versatile storage
- Holds up to 15 kg (33 lbs.)



6 970834 672596



Tool & accessories not included

Case Pack	Case Weight	Case Size	20' FCL
6	7.6 kg (16.7 lbs.)	49 x 41 x 32 cm (19-1/2 x 16 x 12-1/2 in.)	2,610

STORAGE RACK SERIES

329030 Multi-Rack Shelving Unit

- 4 Adjustable particle board shelves
- Lasting powder coated finish resists rust and scratches
- Industrial Strength Steel Construction
- Shelves adjust in 7.5 cm (3 in.) increments



Item No.	Dimension W x D x H	Capacity Per Shelf	Shelf Quantity	Case Weight	Case Size W x D x H	20' FCL	40' FCL
329030	104 x 43 x 183 cm (41 x 17 x 72 in.)	750 kg (1650 lbs.)	4	42 kg (85 lbs.)	102 x 42 x 44 cm (40-1/8 x 16-1/2 x 17-1/4 in.)	108	240



Steel Shelving Unit

- Shelves adjust in 3.8 cm (1-1/2 in.) increments
- Bolt-free assembly design
- Use as a shelf rack or a workbench
- Lasting powder coated finish resists rust and scratches
- Perfect for storing heavy loads in the garage or warehouse



Workbench



Warehouse



329012



Item No.	Dimension W x D x H	Capacity Per Shelf	Shelf Quantity	Case Weight	Case Size W x D x H	20' FCL	40' FCL
329012	122 x 55.9 x 91.5 cm (48 x 22 x 36 in.)	280 kg (617 lbs.)	3	19 kg (42 lbs.)	123 x 59.5 x 7.5 cm (48-1/2 x 22-1/2 x 3 in.)	312	696
329014	76 x 30.5 x 152.5 cm (30 x 12 x 60 in.)	320 kg (705 lbs.)	5	14.5 kg (33 lbs.)	80 x 33 x 9 cm (31-1/2 x 13 x 4-1/8 in.)	920	-
329015	86.4 x 30.5 x 152.5 cm (34 x 12 x 60 in.)	114 kg (250 lbs.)	4	13.2 kg (29 lbs.)	89 x 34 x 7.5 cm (35 x 13-3/8 x 3 in.)	864	1,680
329016	86.5 x 35.5 x 183 cm (34 x 14 x 72 in.)	320 kg (705 lbs.)	5	19.3 kg (44 lbs.)	96 x 39.5 x 9.2 cm (37-3/4 x 15-1/2 x 3-5/8 in.)	616	-
329018	91.5 x 30.5 x 183 cm (36 x 12 x 72 in.)	330 kg (727 lbs.)	5	17.6 kg (37 lbs.)	97 x 34 x 9.5 cm (38-1/4 x 13-1/2 x 3-3/4 in.)	720	1,440

Heavy-Duty Steel Shelving

329020	91.5 x 46 x 183 cm (36 x 18 x 72 in.)	750 kg (1650 lbs.)	5	34 kg (79 lbs.)	96 x 50 x 9.5 cm (37-1/2 x 19-3/4 x 3-3/4 in.)	480	-
329022	122 x 61 x 183 cm (48 x 24 x 72 in.)	580 kg (1270 lbs.)	5	50 kg (110 lbs.)	124 x 65 x 9.5 cm (48-3/4 x 25-1/2 x 3-3/4 in.)	260	-



Premium Steel Shelving Unit

- 5 Shelves adjust in 3.8 cm (1-1/2 in.) increments
- Laminated boards help keep storage area clean
- Lasting powder coated finish resists rust and scratches
- Bolt-free assembly design
- Concealed posts provide a finished appearance
- White color option



Workbench



Item No.	Dimension W x D x H	Capacity Per -Shelf	Shelf Quantity	Case Weight	Case Size W x D x H	20' FCL
329000	76 x 30.5 x 152.5 cm (30 x 12 x 60 in.)	374 kg (824 lbs.)	5	18.5 kg (40.8 lbs.)	80.5 x 33 x 10 cm (31-3/4 x 13 x 4 in.)	920
329002	86.5 x 35.5 x 183 cm (34 x 14 x 72 in.)	374 kg (824 lbs.)	5	22.5 kg (49.6 lbs.)	95 x 38.5 x 11 cm (37-3/8 x 15-1/8 x 4-1/4 in.)	504
329004	91.5 x 46 x 183 cm (36 x 18 x 72 in.)	374 kg (824 lbs.)	5	28.7 kg (63 lbs.)	95.5 x 48.5 x 11 cm (37-1/2 x 19 x 4-1/4 in.)	432
329006	122 x 46 x 183 cm (48 x 18 x 72 in.)	374 kg (824 lbs.)	5	38 kg (84 lbs.)	124 x 50 x 9 cm (48-3/4 x 19-5/8 x 3-1/2 in.)	320



Heavy-Duty Steel Shelving Unit

- 6 Shelves adjust in 3.8 cm (1-1/2 in.) increments
- Laminated boards help keep storage area clean
- Lasting powder coated finish resists rust and scratches
- Bolt-free assembly design
- Industrial strength steel construction



Workbench



Item No.	Dimension W x D x H	Capacity Per -Shelf	Shelf Quantity	Case Weight	Case Size W x D x H	20' FCL
329010B	122 x 46 x 213 cm (48 x 18 x 84 in.)	370 kg (815 lbs.)	6	44.8 kg (99 lbs.)	126.5 x 50.5 x 10.8 cm (49-3/4 x 19-7/8 x 4-1/4 in.)	396

STORAGE RACK SERIES

Ultimax-Rack

- Shelves adjust in 7.5 cm (3 in.) increments
- Adjustable grid pattern wire shelving
- Industrial strength steel construction
- Welded and frames to support heavy loads
- Lasting powder coated finish resists rust and scratches
- Wire shelves for ventilation and multi-use storage
- Double punched posts allows connection of multiple units



Tools not included



329049B



329050B



329052B



Item No.	Dimension W x D x H	Capacity Per -Shelf	Shelf Quantity	Case Weight	Case Size W x D x H	20' FCL	40' FCL
329049B	122 x 58 x 91.5 cm (48 x 22-3/4 x 36 in.)	450 kg (990 lbs.)	2	25 kg (55 lbs.)	121 x 63 x 21 cm (47-5/8 x 24-3/4 x 8-1/4 in.)	143	308
329050B	195.5 x 61 x 183 cm (77 x 24 x 72 in.)	820 kg (1800 lbs.)	4	61.3 kg (135 lbs.)	193 x 66 x 25 cm (72 x 26 x 9-7/8 in.)	64	144
329052B	195.5 x 61 x 183 cm (77 x 24 x 72 in.)	820 kg (1800 lbs.)	3	53 kg (116.8 lbs.)	193 x 66 x 25 cm (72 x 26 x 9-7/8 in.)	64	144

Ultimax-Rack

- Shelves adjust in 7.5 cm (3 in.) increments
- Adjustable particle board shelves
- Industrial Strength Steel Construction
- Welded and frames to support heavy loads
- Lasting powder coated finish resists rust and scratches
- Double punched posts allows connection of multiple units



Item No.	Dimension W x D x H	Capacity Per -Shelf	Shelf Quantity	Case Weight	Case Size W x D x H	20' FCL	40' FCL
329054	195.5 x 46 x 183 cm (77 x 18 x 72 in.)	770 kg (1700lbs.)	3	61 kg (134.5 lbs.)	193 x 49 x 25.7 cm (76 x 19-1/4 x 10-1/8 in.)	96	192
329056	195.5 x 61 x 183 cm (77 x 24 x 72 in.)	770 kg (1700lbs.)	3	68 kg (150 lbs.)	193 x 66 x 25.7 cm (76 x 26 x 10-1/8 in.)	64	144
329058	195.5 x 76 x 183 cm (77 x 30 x 72 in.)	770 kg (1700 lbs.)	3	89 kg (192 lbs.)	193 x 81 x 25.7 cm (76 x 31-7/8 x 10-1/8 in.)	48	112



329080 Heavy Duty 4 Shelf Unit

- Adjustable particle board shelves
- Industrial strength steel construction
- Bolt-free assembly design
- Lasting powder coated finish resists rust and scratches
- Perfect to store heavy loads in the office, home, garage or warehouse



Tools not included



Item No.	Dimension W x D x H	Capacity Per -Shelf	Shelf Quantity	Case Weight	Case Size W x D x H	20' FCL	40' FCL
329080	160 x 60 x 180 cm (63 x 24 x 72 in.)	350 kg (770 lbs.)	4	45 kg (99 lbs.)	159 x 59 x 7.5 cm (63 x 23 x 3 in.)	312	672

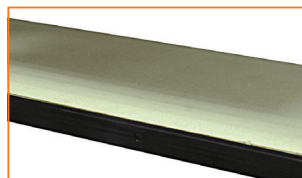

Adjustable particle board shelves



Lasting powder coated finish resists rust & scratches



Bolt-free assembly design

329103 Standard Storage Racks

- Corrosion resistant powder coat finish
- Sturdy solid steel construction
- Adjustable particle board shelving
- Shelves adjustable in 3.5 cm (1-3/8 in.) increments
- Bolt-free assembly design



Item No.	Dimension W x D x H	Capacity Per -Shelf	Shelf Quantity	Case Weight	Case Size W x D x H	20' FCL	40' FCL
329103	76 x 30.5 x 152.5 cm (30 x 12 x 60 in.)	135 kg (300 lbs.)	4	13 kg (28.6 lbs.)	80.5 x 35 x 9.5 (31-5/8 x 13-3/4 x 3-3/4 in.)	880	-

320400 4-Tier Plastic Shelf Unit

- Resin construction
- Solid surface shelves
- Easy to clean
- Will not rust, dent or peel
- Indoor/outdoor use
- Easy to assemble - No Tools Required

Holds up to
**30 kg
(66 lbs.)**
per shelf



No tools required



Tools not included



Item No.	Dimension W x D x H	Capacity Per -Shelf	Shelf Quantity	Case Weight	Case Size W x D x H	20' FCL	40' FCL	40' HQ
320400	56 x 35.6 x 126.2 cm (22 x 14 x 49-5/8 in.)	30 kg (66 lbs.)	4	4 kg (8.8 lbs.)	56 x 35.5 x 15.5 cm (22 x 14 x 6-1/8 in.)	960	1,980	2,244



Easy to assemble; makes for solid construction

320402 5-Tier Plastic Shelf Unit

- Resin construction
- Solid surface shelves
- Easy to clean
- Will not rust, dent or peel
- Indoor/outdoor user
- Easy to assemble - No Tools Required

Holds up to
**30 kg
(66 lbs.)**
per shelf



No tools required

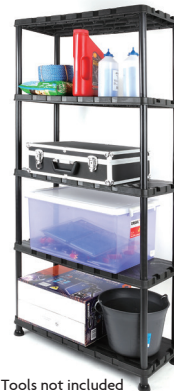

Tools not included



Item No.	Dimension W x D x H	Capacity Per -Shelf	Shelf Quantity	Case Weight	Case Size W x D x H	20' FCL	40' FCL	40' HQ
320402	74 x 32 x 171 cm (29-1/8 x 12-1/2 x 67-1/4 in.)	30 kg (66 lbs.)	5	6.3 kg (14 lbs.)	74 x 32 x 18 cm (29-1/8 x 12-1/2 x 7 in.)	702	1,443	1,554

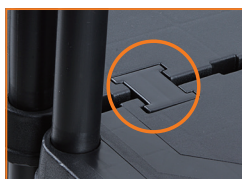

Easy to assemble;
makes for solid construction

Units can be connected
for additional storage



323502 46 cm (18 in.) Zippered Closed Tool Bag

- 46 W x 28 D x 30 H cm (18 x 11 x 12-3/4 in.)
- Durable and Water-resistant
- Padded shoulder strap
- Comfortable heavy duty hand grips
- Large center compartment
- Sturdy elevated base
- Removable interior divider



Case Pack	Case Weight	Case Size	20' FCL	40' FCL
4	10.2 kg (22 lbs.)	57 x 41 x 56 cm (22-1/2 x 16-1/8 x 22 in.)	896	1,856



323504 46 cm (18 in.) Rolling Tool Bag

- 46 W x 27.5 D x 39.5 H cm (18 x 10-3/4 x 15-1/2 in.)
- Durable and Water-resistant
- 14 Specialized pockets for a variety of tools
- Large capacity interior holds tools for any job
- 3 Stage handle extends and locks
- Large main opening stays open
- Rigid bottom handle for easy lifting
- Rugged over-sized wheels



Case Pack	Case Weight	Case Size	20' FCL	40' FCL
1	6.5 kg (14 lbs.)	49 x 30 x 50 cm (19-1/4 x 11-3/4 x 19-5/8 in.)	308	672



323506 41 cm (16 in.) Tool Backpack

- 41 W x 21.6 D x 55.8 H cm (16 x 8-1/2 x 22 in.)
- Durable and Water-resistant
- Rugged waterproof base
- Protective compartment for precision equipment
- Technology pocket includes padded pocket for laptops
- Specialized pockets allows user to organize and keep track of smaller items inside main bag compartment



Case Pack	Case Weight	Case Size	20' FCL	40' FCL
2	6.5 kg (14 lbs.)	38 x 38 x 50 cm (15 x 15 x 19-5/8 in.)	720	1,488



• Comfortable heavy duty hand grips



• Large center compartment



• Removable interior divider



• Sturdy elevated base

323500 55 cm (21-1/2 in.) Zippered Closed Tool Bag

Case Pack	Case Weight	Case Size	20' FCL	40' FCL
4	11.5 kg (25 lbs.)	57.5 x 50.5 x 50 cm (22-5/8 x 19-7/8 x 19-5/8 in.)	704	1,472



323508 32 cm (12-1/2 in.) Tool Backpack

- 32 W x 22.2 D x 42 H cm (12-1/2 x 8-3/4 x 16-1/2 in.)
- Durable and Water-resistant
- Sturdy elevated base
- Protective compartment for precision equipment
- Technology pocket includes padded pocket for laptops
- Specialized pockets allows user to organize and keep track of smaller items inside main bag compartment



Case Pack	Case Weight	Case Size	20' FCL	40' FCL
4	8.1 kg (18 lbs.)	49 x 40 x 29 cm (19-1/4 x 15-3/4 x 11-3/8 in.)	1,760	3,840



323512 25.4 cm (10 in.) Electrician Tote Tool Bag

- 25.4 W x 33 D x 40.6 H cm (10 x 13 x 16 in.)
- Durable and Water-resistant
- Padded shoulder strap
- 34 Specialized pockets for a variety of tools
- Protective compartment for precision equipment
- Elevated base with sturdy feet
- High side walls keep longer tools from falling out when transporting



Case Pack	Case Weight	Case Size	20' FCL	40' FCL
6	14.3 kg (32 lbs.)	80 x 32 x 53 cm (31-1/2 x 12-1/2 x 20-7/8 in.)	1,200	2,520



323514 Tool Belt

- Durable and Water-resistant
- Large capacity tool pouches for maximum storage
- Includes monster hook tool holder
- Removable carrying handles for easy transport
- Includes padded suspenders to help distribute weight and maximize comfort
- Fits up to a 50-in waist



Case Pack	Case Weight	Case Size	20' FCL	40' FCL
4	8.1 kg (18 lbs.)	72 x 33 x 25 cm (28-1/4 x 13 x 9-7/8 in.)	2,016	4,032



• Rotating handle swings 180 degrees

• Large center compartment

• Protective compartment

• Sturdy waterproof base

323510 56 cm (22 in.) Tool Tote Bag

Case Pack	Case Weight	Case Size	20' FCL	40' FCL
4	11.8 kg (26 lbs.)	56 x 54.5 x 47 cm (22 x 21-1/2 x 18-1/2 in.)	800	1,760





- Open bag for quick access
- Aluminum handle
- Heavy-duty high quality material



Dimension:
47 x 24.5 x 27cm
(18-1/2 x 9-5/8 x 10-5/8 in.)

- Multiple compartments for maximum organization

323163 47 cm (18-1/2 in.) Open Tote Tool Bag

Case Pack	Case Weight	Case Size	20' FCL	40' FCL
4	9.4 kg (21 lbs.)	52 x 47.5 x 56.5 cm (20-3/8 x 18-5/8 x 22-1/4 in.)	768	1,600



SOFT STORAGE

323141 50.7 cm (20 in.) Gate Mouth Tool Bag

- 50.7 W x 29.4 D x 30.5 H cm (20 x 11-1/2 x 12 in.)
- Open bag for quick access
- Ideal for hand tools and other small items
- Multiple compartments for maximum organization



Tools not included



6 942629 229643

Case Pack	Case Weight	Case Size	20' FCL	40' FCL
6	10.7 kg (24 lbs.)	58 x 38 x 32 cm (23 x 15 x 32 in.)	2,520	5,292

323143 40.5 cm (16 in.) Gate Mouth Tool Bag

- 40.5 W x 28 D x 30.5 H cm (16 x 11 x 12 in.)
- Open bag for quick access
- Ideal for hand tools and other small items
- Multiple compartments for maximum organization



Tools not included



6 942629 229650

Case Pack	Case Weight	Case Size	20' FCL	40' FCL
6	8.1 kg (18 lbs.)	49.5 x 37 x 30 cm (19-1/2 x 14-1/2 x 11-3/4 in.)	2,898	6,090

323145 30.5 cm (12 in.) Gate Mouth Tool Bag

- 30.5 W x 25.4 D x 28 H cm (12 x 10 x 10-1/2 in.)
- Open bag for quick access
- Ideal for hand tools and other small items
- Multiple compartments for maximum organization



Tools not included



6 942629 229667

Case Pack	Case Weight	Case Size	20' FCL	40' FCL
6	5.2 kg (11 lbs.)	38.5 x 38.5 x 26.5 cm (15-1/8 x 15-1/8 x 10-3/8 in.)	3,600	7,200

323165 Utility Tote Tool Bag

- 40.5 W x 30.5 D x 24.2 H cm (16 x 12 x 9-1/2 in.)
- Collapsible when empty
- Includes 6 outside pocket
- Comfort wide fabric handle



Tools not included



6 942629 229698

Case Pack	Case Weight	Case Size	20' FCL	40' FCL
10	12.1 kg (27 lbs.)	45 x 42 x 33 cm (17-3/4 x 16-1/2 x 13 in.)	4,800	9,600

18
POCKETS



323147 Tool Backpack

- 47 W x 35 D x 28 H cm (18-1/2 x 13-3/4 x 11 in.)
- Two main zippered compartments, one for tools and parts, one for a laptop and notebooks
- Shoulder straps with extra padding & handles for easy carrying



Case Pack	Case Weight	Case Size	20' FCL	40' FCL	40' HQ
6	8.2 kg (18 lbs.)	54 x 40.5 x 51 cm (21-1/4 x 16 x 20 in.)	1,440	2,976	3,720



Tools not included



Tools not included

44
POCKETS



323170 Tool Backpack

- 42.5 W x 34 D x 31.5 H cm (16-3/4 x 13-3/8 x 12-3/8 in.)
- Material: constructed of 600 denier heavy-duty
- Two main zippered compartments
- 38x Pockets and belts inside and 6 pockets outside
- Tape holder

NEW



Tools not included



Case Pack	Case Weight	Case Size	20' FCL	40' FCL	40' HQ
4	8.4 kg (18.5 lbs.)	45 x 37 x 56 cm (17-5/8 x 14-1/2 x 22 in.)	1,288	2,640	3,012



Rear compartment



Tape holder



Adjustable compression pocket



4 Rubber feet on the bottom to keep your tools dry in wet conditions



Padded back support and shoulder straps with adjustable chest strap



Front compartment



Tools not included

SOFT STORAGE

323157 50 cm (19-1/2 in.) Mobile Tool Bag

- 50 W x 36 D x 21 H cm (19-1/2 x 14-1/8 x 8-1/4 in.)
- Two main zippered compartments, one for tools and parts, one for a laptop and notebooks
- Shoulder straps with extra padding and handles for easy carrying
- Telescopic extension handle
- 2 x Wheels allows for easy mobility



Case Pack	Case Weight	Case Size	20' FCL	40' FCL	40' HQ
2	6 kg (13 lbs.)	53.5 x 39 x 30.5 cm (21 x 15-3/8 x 12 in.)	868	1,764	2,016



Tools not included

18
POCKETS



323172 18-1/2 in. Hard Base Rolling Tool Bag

- 47 W x 34 D x 42 H cm (18-1/2 x 13-1/4 x 16-1/2 in.)
- 47 W x 34 D x 104.5 H cm (18-1/2 x 13-1/4 x 41-1/8 in.) Telescopic lift-out
- 600 Denier polyester construction
- Reinforced rubber base
- Dual zipped opening
- 1 x Tape measure clip and card pocket on the side
- Hard removable divider to arrange your space

NEW

11
ELASTIC
LOOPS



Case Pack	Case Weight	Case Size	20' FCL	40' FCL	40' HQ
2	9.3 kg (20.5 lbs.)	47 x 70 x 45 cm (18-1/2 x 27-1/2 x 17-3/4 in.)	370	760	760



12 Inside pockets & 11 elastic loops 8 Outside pockets

Card pocket on the side

Sturdy casters with extra-stable wide stance

20
POCKETS



Tools not included



323153 14 cm (5-1/2 in.) Utility Bag

- 14 W x 14 D x 21.5 H cm (5-1/2 x 5-1/2 x 8-1/2 in.)
- 6 Interior drawstring compartments
- 4 External pockets
- Carrying strap for easy transportation



Tools not included



Case Pack	Case Weight	Case Size	20' FCL	40' FCL
12	3.5 kg (8 lbs.)	45 x 56 x 24.5 cm (17-3/4 x 22 x 9-5/8 in.)	5,616	11,232



323167 Bucket Organizer

- Ideal for hand tools and other small items
- Multiple easy access pockets and compartments



Tools not included



Case Pack	Case Weight	Case Size	20' FCL	40' FCL
30	22.6 kg (50 lbs.)	52 x 52 x 83 cm (20-1/2 x 20-1/2 x 32-3/4 in.)	3,510	7,320



323161 25.4 cm (10 in.) Electrician Tote Tool Bag

- 25.4 W x 25.4 D x 25.4 H cm (10 x 10 x 10 in.)
- Open bag for quick access
- Ideal for hand tools and other small items
- Multiple compartments for maximum organization



Case Pack	Case Weight	Case Size	20' FCL	40' FCL
8	14.3 kg (32 lb)	54.5 x 54.5 x 53 cm (21-1/2 x 21-1/2 x 20-7/8 in.)	1,280	2,688



Tools not included



Aluminum handle



323169 16 Of Pockets Electricians Tool Pouch

- 16 Pockets
- Ideal for hand tools and other small items commonly used by electricians, plumbers and wood workers
- Multiple compartments for maximal organization potential



Tools not included



Inner Pack	Case Pack	Case Weight	Case Size	20' FCL	40' FCL
0	12	10.6 kg (23 lbs.)	57.5 x 49 x 30 cm (22-5/8 x 19-1/2 x 11-3/4 in.)	3,696	8,064

SOFT STORAGE

323155 30.5 cm (12 in.) Zipper Organizer

- 30.5 x 19 cm (12 x 7-1/2 in.)
- Material: Constructed of 1680 Denier heavy-duty
- Front pocket for business card storage
- Two compartments inside for maximum organization
- Carry and organize your miscellaneous parts, tools and accessories



Contents not included



Inner Pack	Case Pack	Case Weight	Case Size	20' FCL	40' FCL
24	56	3.9 kg (9 lbs.)	33 x 22 x 29.5 cm (13 x 8-5/8 x 11-1/2 in.)	31,080	64,008



323003 3 Pack Organizers

- 3 Different sizes and colors
- Includes mini carabiner



Contents not included



Inner Pack	Case Pack	Case Weight	Case Size	20' FCL	40' FCL
14	56	9.7 kg (21 lbs.)	50 x 30 x 41 cm (19-1/2 x 11-3/4 x 16 in.)	28,000	56,000



323090 Note Book Holder

- 25.5 W x 34 D x 4 H cm (10 x 14 x 1-5/8 in.)
- Material: constructed of 1680 denier heavy-duty
- Calculator including
- Spring clip insides
- Different pocket for different function



Business cards, stationary not included



Case Pack	Case Weight	Case Size	20' FCL	40' FCL
10	6.9 kg (15 lbs.)	34 x 27.5 x 35 cm (13-1/4 x 10-3/4 x 13-3/4 in.)	9,000	18,000



323092 Note Book Holder

- 23 W x 16.5 D x 2 H cm (9 x 6-1/2 x 4/5 in.)
- Material: constructed of 1680 denier heavy-duty
- Different pocket for different function



Business cards, stationary not included



Case Pack	Case Weight	Case Size	20' FCL	40' FCL
20	4.5 kg (10 lbs.)	45 x 20 x 25 cm (17-3/4 x 7-3/4 x 9-3/4 in.)	27,000	54,000





Tools not included

323005 7 Pockets Tool Belt Pouch

- Belt hole for easy attachment
- 7 Pockets for convenient storage of your tools



Inner Pack	Case Pack	Case Weight	Case Size	20' FCL	40' FCL
12	72	8.9 kg (19.6 lbs.)	79 x 36 x 29 cm (31 x 14 x 11-1/2 in.)	26,064	55,080



Tools not included

323007 2 Pockets Tool Belt Pouch

- Belt hole for easy attachment
- 2 Pockets for convenient storage of your tools



Inner Pack	Case Pack	Case Weight	Case Size	20' FCL	40' FCL
16	96	8.7 kg (19 lbs.)	52 x 35 x 26 cm (20-1/2 x 13-3/4 x 10-1/4 in.)	55,200	110,400



Tools not included

323061 Leather Hammer Hanger

- Angled steel loop holds hammer securely



Inner Pack	Case Pack	Case Weight	Case Size	20' FCL	40' FCL
12	48	7.1 kg (16 lbs.)	42 x 38 x 25 cm (16-1/2 x 15 x 9-7/8 in.)	36,000	72,000



Tools not included

323062 Hammer Hanger

- Angled steel loop holds hammer securely



Inner Pack	Case Pack	Case Weight	Case Size	20' FCL	40' FCL
10	60	11.5 kg (25 lbs.)	54 x 40 x 26 cm (21-1/4 x 15-3/4 x 10-1/4 in.)	33,000	68,040

SOFT STORAGE

323001 8 Pockets Tool Belt Pouch

- Belt hole for easy attachment
- 8 Pockets for convenient storage of your tools



Tools not included



Case Pack	Case Weight	Case Size	20' FCL	40' FCL
16	7.2 kg (16 lbs.)	54 x 42 x 27 cm (21-1/4 x 16-1/2 x 10-5/8 in.)	7,760	16,480



323011 Drill Holster

- 18.2 W x 5.5 D x 35 H cm (7-1/8 x 2-1/8 x 13-3/4 in.)
- 600 Denier polyester material provides strength and durability
- Angled holster provides better drill balance
- Adjustable Strap and Quick-Release Buckle
- Added Pockets and Elastic Loops

NEW



Tools not included



Case Pack	Case Weight	Case Size	20' FCL	40' FCL	40' HQ
20	7 kg (15.4 lbs.)	40 x 37 x 37 cm (15-3/4 x 14-1/2 x 14-1/2 in.)	10,440	22,320	26,040



323033 Tool Belt

- Exterior of nail pocket is magnetized for storing small tools
- Key stress points are reinforced with rivets
- Main pockets stay open for easy access
- Sturdy steel hammer holder



Case Pack	Case Weight	Case Size	20' FCL	40' FCL
8	8 kg (17.6 lbs.)	60 x 40 x 29 cm (23-1/2 x 15-3/4 x 11-1/2 in.)	3,400	6,800



Tools not included



Tools not included

323150 Soft Bag Belt

- Fit for soft storage items



Inner Pack	Case Pack	Case Weight	Case Size	20' FCL	40' FCL
12	48	22 kg (49 lbs.)	32 x 25 x 25 cm (20 x 13-3/8 x 20-7/8 in.)	72,000	144,000



ITEM NO.	PAGE NO.	ITEM NO.	PAGE NO.	ITEM NO.	PAGE NO.	ITEM NO.	PAGE NO.	ITEM NO.	PAGE NO.
320001	31	320064	10	320162	43	320310B	22	320603	56
320001N	32	320067	39	320180	44	320311	83	320604	56
320002	29	320068	39	320200	78	320312	8	320606	56
320003	29	320070	76	320202	78	320314	23	320608	57
320004	29	320072	76	320206	78	320316	8	320610	56
320005	29	320074	76	320208	78	320318	7	320612	57
320006	29	320076	45	320210	79	320322	18	320616	57
320007	29	320077	45	320212	78	320324	18	320618	57
320008	30	320078	45	320216	79	320332	8	320619	59
320009	30	320079	45	320218	79	320336	8	320620	59
320010	30	320080	37	320230	81	320340	9	320621	59
320011	30	320081	37	320231	71	320341	4	320622	58
320016	31	320082	12	320232	80	320342	4	320624	84
320016N	32	320082C	14	320233	71	320343	4	320625	84
320017	31	320084	12	320235	81	320344	4	320630	62
320017N	32	320084C	14	320238	73	320345	4	320632	63
320018	31	320086	12	320239	72	320348	9	320634	63
320018N	32	320086C	14	320240	73	320350	9	320636	65
320019	31	320087	13	320241	73	320352	83	320638	64
320020	34	320088	13	320242	73	320360	25	320644	65
320021	33	320090	77	320243	74	320361	25	320648	64
320022	33	320092	77	320244	74	320362	25	320649	59
320023	33	320094	77	320245	74	320364	26	320650	47
320024	33	320100A	3	320246	75	320365	26	320651	47
320026	34	320101	3	320247	75	320366	27	320652	47
320027	35	320103	3	320248	73	320367	27	320654	48
320028	35	320104	82	320249	74	320368	27	320655	47
320030	30	320105	82	320250	75	320369	25	320656	50
320032	30	320106	82	320251	73	320370	26	320658	51
320033	34	320107	3	320252	74	320380	9	320660	49
320034	35	320110	5	320254	79	320390	10	320662	49
320038	34	320111	5	320260	67	320392	10	320670	52
320040	39	320112	5	320262	67	320394	10	320672	53
320041	36	320114	5	320264	67	320400	143	320674	54
320042	36	320118	5	320266	68	320402	143	320676	55
320043	36	320130	2	320268	69	320500	20	320680	60
320044	38	320132	2	320270	69	320502	20	320681	60
320047	39	320134	2	320280	68	320504	20	320682	60
320048	38	320138	2	320282	68	320506	20	320900	82
320050	41	320140	58	320300	7	320508	21	320901	82
320052	41	320142	37	320302	22	320520	21	321100	85
320054	41	320144	37	320304	7	320530	21	321101	85
320056	44	320150	43	320308	22	320600	58	321102	85
320060	38	320152	43	320309	83	320601	57	321103	85
320062	38	320160	43	320310	22	320602	83	321105	6

ITEM NO.	PAGE NO.	ITEM NO.	PAGE NO.	ITEM NO.	PAGE NO.	ITEM NO.	PAGE NO.	ITEM NO.	PAGE NO.
321106	6	323145	147	326084	110	326262	125	326502	102
321107	6	323147	148	326085	114	326263	125	326504	103
321108	18	323150	153	326086	111	326264	125	326506	103
321109	86	323153	150	326087	112	326265	126	326902	61
321110	86	323155	151	326088	113	326270	130	326903	61
321111	86	323157	149	326089	112	326271	128	328100	135
321112	86	323161	150	326090	113	326272	129	328102	136
321113	86	323163	146	326091	112	326273	130	328104	136
321114	86	323165	147	326100	117	326274	129	328106	136
321118	18	323167	150	326101	117	326275	129	328108	136
321120	16	323169	150	326102	117	326276	130	328110	137
321121	16	323170	148	326103	117	326280	128	328112	137
321122	16	323172	149	326115	126	326281	132	328114	137
321123	16	323500	144	326126	126	326282	132	328116	137
321130	17	323502	144	326127	126	326283	132	328118	138
321131	17	323504	144	326128	126	326284	134	328120	138
321132	17	323506	144	326129	126	326285	133	328122	138
321133	17	323508	145	326130	126	326286	133	328124	138
321160	40	323510	145	326131	126	326287	133	328126	138
321162	40	323512	145	326132	126	326288	134	329000	140
321164	40	323514	145	326133	126	326289	134	329002	140
321210	87	326001	92	326134	126	326290	134	329004	140
321212	87	326002	93	326135	126	326301	96	329006	140
321220	87	326004	92	326136	126	326302	97	329010B	140
321221	87	326005	93	326137	126	326304	96	329012	139
321222	87	326007	91	326138	126	326305	97	329014	139
321310	89	326008	91	326139	126	326307	97	329015	139
321312	89	326009	91	326140	126	326308	97	329016	139
321314	89	326023	107	326141	126	326320	100	329018	139
321700	88	326024	107	326200	116	326322	100	329020	139
321702	88	326026	106	326201	116	326324	100	329022	139
321704	88	326027	106	326231	122	326371	98	329030	139
321706	88	326038	123	326232	122	326372	98	329049B	141
323001	153	326039	123	326233	122	326373	98	329050B	141
323003	151	326060	115	326234	123	326400	104	329052B	141
323005	152	326061	115	326235	123	326402	109	329054	141
323007	152	326062	115	326237	123	326403	104	329056	141
323011	153	326071	94	326246	123	326424	105	329058	141
323033	153	326072	94	326250	119	326428	105	329080	142
323061	152	326076	115	326251	119	326430	108	329103	142
323062	152	326077	115	326252	119	326432	108		
323090	151	326080	110	326253	120	326434	109		
323092	151	326081	111	326254	120	326436	109		
323141	147	326082	110	326255	120	326438	109		
323143	147	326083	111	326261	125	326500	102		

Horizontal dashed lines for note-taking.

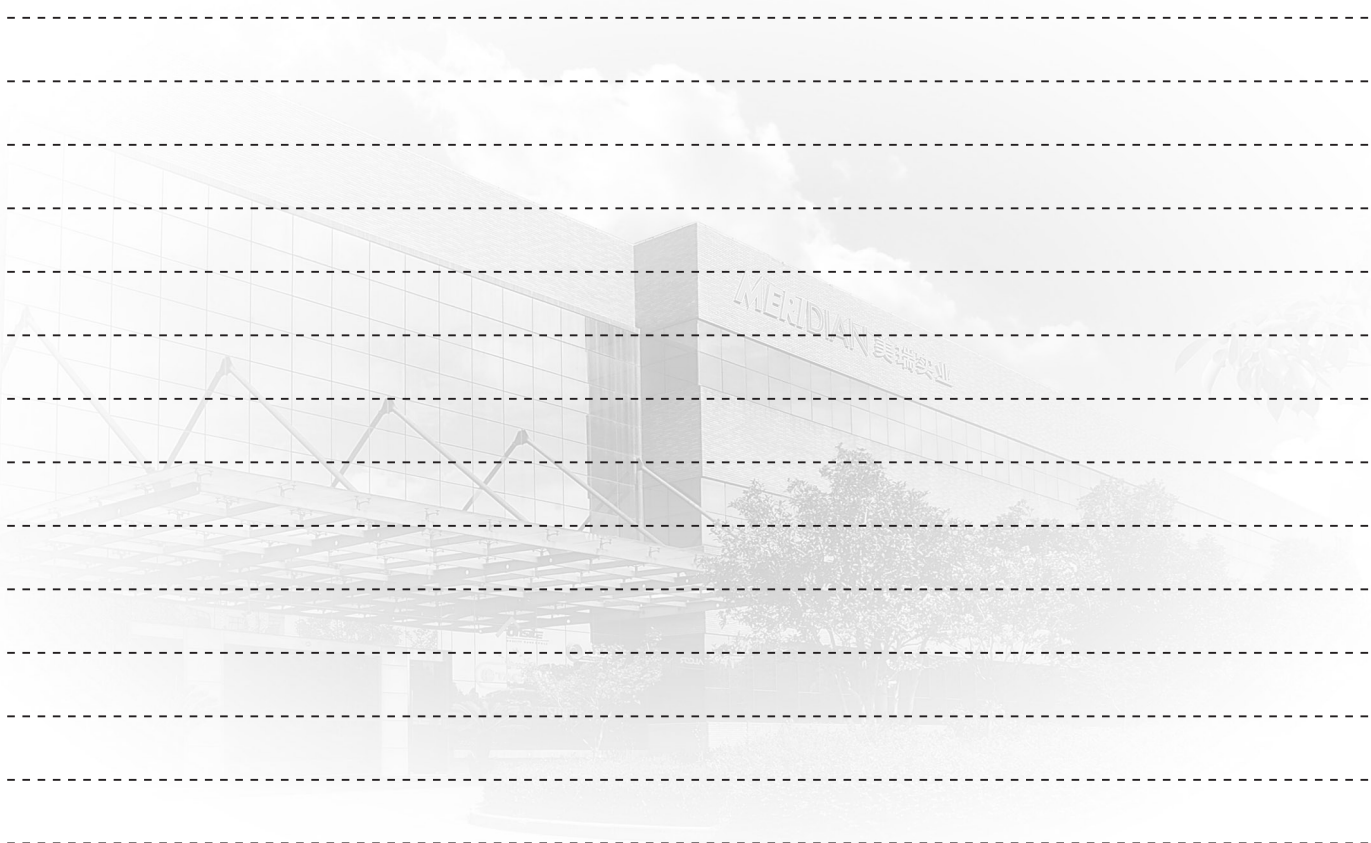

A series of horizontal dashed lines for writing notes, overlaid on a faint background image of a modern glass building with the word 'MERIDIAN' visible on its facade.

A series of horizontal dashed lines for writing notes, overlaid on a faint background image of a modern building with a glass facade and a canopy entrance. The building has the word 'MERIDIAN' and Chinese characters '美瑞实业' visible on its facade.

A series of horizontal dashed lines spanning the width of the page, providing a template for handwritten notes.

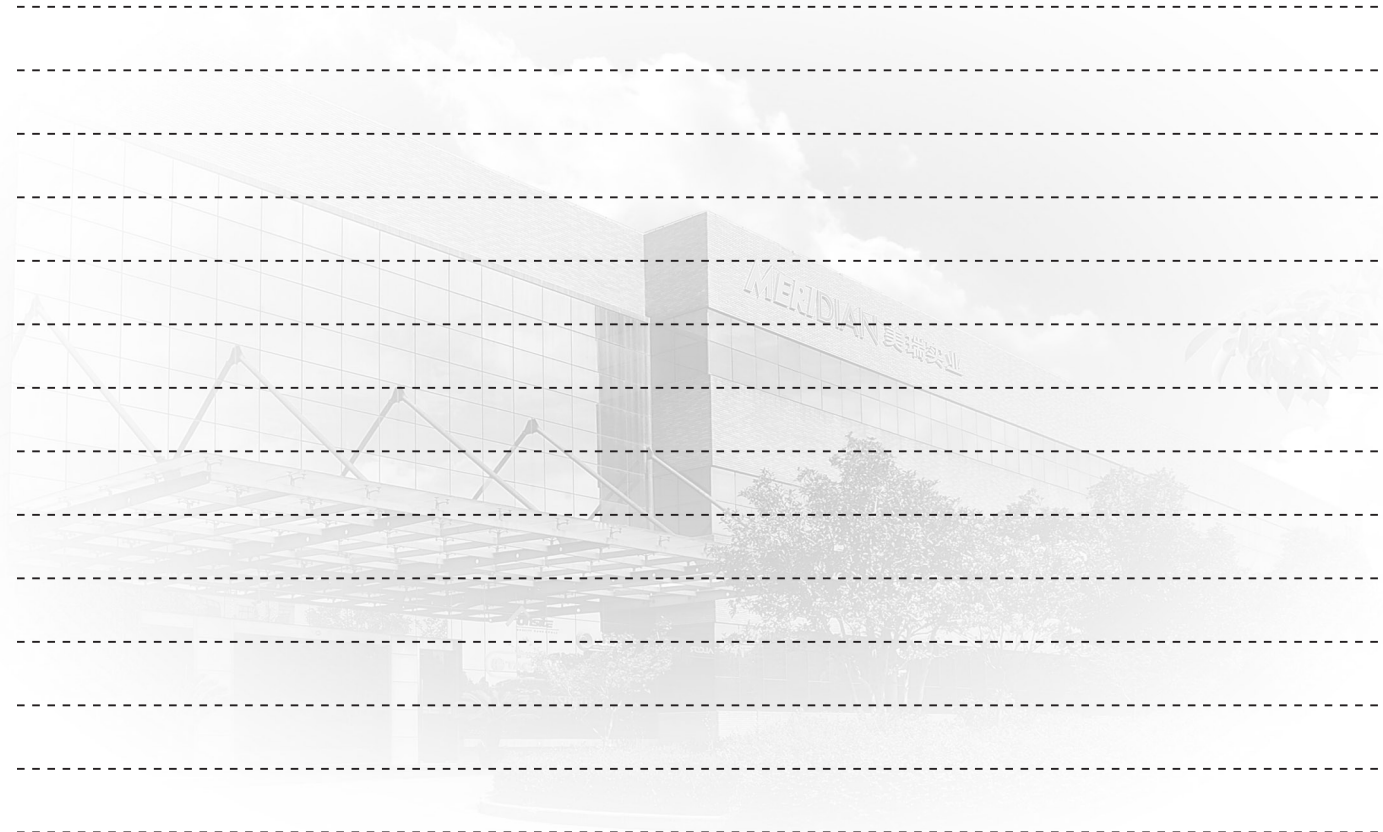

MERIDIAN

美瑞实业



Meridian International Co., Ltd.

1886 Laiyin Road, Songjiang, Shanghai, China

Tel: (021) 3763 3311

Fax: (021) 3763 3322 3763 3355

www.meridianintl.com

Distributed by



STORAGE SOLUTIONS CATALOGUE 2021